

SINCE 1889



Rotary Evaporator

Model

RE601/801

(Take in vacuum controller(VR))

Instruction Manual

- The Second Edition -

This document is the exclusive instruction manual to the RE601/801 model rotary evaporator main unit and the VR601/801 model vacuum controller.

- Thank you for purchasing "Rotary Evaporator, RE Series" of Yamato Scientific Co., Ltd.
- To use this unit properly, read this "Instruction Manual" thoroughly before using this unit. Keep this instruction manual around this unit for referring at anytime.



WARNING!

Carefully read and thoroughly understand the important warning items described in this manual before using this unit.

Yamato Scientific Co. LTD.

Contents

◆ 1.Contents in the Package.....	1
◆ 2.Cautions in Using with Safety.....	2
• Explanation.....	2
• Table of Illustrated Symbols	3
• Fundamental Matters of "WARNING!" and "CAUTION!"	4
◆ 3.Before Using This Unit.....	6
◆ 4.Outside Appearance.....	9
• RE601/801 model installation.....	9
• Vacuum Controller.....	10
◆ 5.Installation Method.....	11
• RE601/801 model installation.....	11
• Installation Method	12
• Connecting method and assembling procedures of glass unit.....	18
◆ 6.Control Panel.....	25
• Control Panel (Main unit).....	25
• Control Panel (Vacuum Controller).....	26
◆ 7.Operation Function	27
• Basic Operation.....	27
• Operational Function for Vacuum Controller	29
• Key Functions and Operations	30
◆ 8.Operation	35
• Standby Screen/Operation Mode Selection Screen	35
• Operation Setting Screen.....	36
• Name Registration.....	37
• Data Operation	39
• Free Operation	41
• Fixed Temperature Operation.....	42
• Fixed Temperature Timer Operation.....	44
• Descending Operation Procedures	46
• Descending Timer Operation Procedures	48
• Automatic Operation I Procedures	50
• Automatic Operation II Procedures.....	52
◆ 9.Description and Function of Each Part	53
◆ 10.Exchange procedure of Pressure Sensor	55
◆ 11.Handling Precautions	58
◆ 12.Maintenance Method.....	59
◆ 13.Long storage and disposal.....	60
◆ 14.In the Event of Failure... ..	61
• Safety Device and Error Code.....	61
• Trouble Shooting	63
◆ 15.After Service and Warranty	64

◆ 16.Specification	65
◆ 17.Wiring Diagram.....	67
◆ 18.Replacement Parts Table.....	69
◆ 19.List of Dangerous Materials	71
◆ 20. Standard Installation Manual.....	72

1.Contents in the Package

Contents in the Package

Affirmation of content package

Check the content of package before setting up the device.

Contact our selling office or sales office if any components or parts are missing.

RE601/801 main unit(main unit and appurtenant)				
No.	Name	QTY	Notes	check
1	RE601/801 main unit	1 set		
2	Vacuum seal	1		
3	Condenser fixing nut	1		
4	Coil ring	1		
5	Rotary joint retainer	1		
6	Ring(large/middle/small)	each 1		
7	O-ring	2		
8	Vacuum grease	1		
9	Power cord	1		
10	Bath ways	1		
11	Instruction manual	1		
12	Warranty card	1		
13	Battery(9V alkaline dry cell)	2		

Caution: Please check being attached to RE main part about 1-7.

Vacuum controller(VR) (VE601/801 main unit and appurtenant)				
No.	Name	QTY	Notes	check
1	Vacuum controller(VR) main unit	1 set	Refer to the instruction manual for vacuum controller model VR/601/801.	
2	RE body fixing screw	3		
3	DC24V power harness	1		
4	Bracket vacuum controller	1	At the time of shipping, RE main unitfixation	
5	Rotor jack signal harness	1		
6	Evaporation temperature sensor	1	Appurtenant: Sensor cover, Sensor packing(silicone)	
7	Bath signal harness	1		
8	Vacuum hose	1m		

2.Cautions in Using with Safety

Explanation

MEANING OF ILLUSTRATED SYMBOLS

Illustrated Symbols

Various symbols are used in this safety manual in order to use the unit without danger of injury and damage of the unit. A list of problems caused by ignoring the warnings and improper handling is divided as shown below. Be sure that you understand the warnings and cautions in this manual before operating the unit.

 **WARNING!** If the warning is ignored, there is the danger of a problem that may cause a serious accident or even fatality.

 **CAUTION!** If the caution is ignored, there is the danger of a problem that may cause injury/damage to property or the unit itself.

Meaning of Symbols



This symbol indicates items that urge the warning (including the caution). A detailed warning message is shown adjacent to the symbol.



This symbol indicates items that are strictly prohibited. A detailed message is shown adjacent to the symbol with specific actions not to perform.



This symbol indicates items that should be always performed. A detailed message with instructions is shown adjacent to the symbol.

2.Cautions in Using with Safety

Table of Illustrated Symbols

Warning



Warning,
generally



Warning,
high voltage



Warning,
high temperature



Warning,
drive train

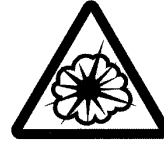

Warning,
explosive

Caution



Caution,
generally



Caution,
electrical shock



Caution,
scald



Caution,
no road heating



Caution,
not to drench



Caution,
water only



Caution,
deadly poison



Caution,
water

Prohibit



Prohibit,
generally



Prohibit,
inflammable



Prohibit,
to disassemble



Prohibit,
to touch

Compulsion



Compulsion,
generally



Compulsion,
connect to the
grounding
terminal



Compulsion,
install on a flat
surface



Compulsion,
disconnect the
power plug



Compulsion,
periodical
inspection

2.Cautions in Using with Safety

Fundamental Matters of "WARNING!" and "CAUTION!"

WARNING!

Do not use this unit in an area where there is flammable or explosive gas

Never use this unit in an area where there is flammable or explosive gas. This unit is not explosion-proof. An arc may be generated when the power switch is turned on or off, and fire/explosion may result. (Refer to page 71 "19.List of Dangerous Materials".)

Always ground this unit

Always ground this unit on the power equipment side in order to avoid electrical shock due to a power surge.

Plug the power cord securely

Plug the power cord securely into the main unit. If not, overheat or fire disaster may result in.

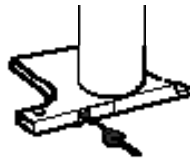

If a problem occurs

If smoke or strange odor should come out of this unit for some reason, turn off the circuit breaker right away, and then disconnect the power plug. Immediately contact a service technician for inspection. If this procedure is not followed, fire or electrical shock may result. Never perform repair work yourself, since it is dangerous and not recommended.

Do not use the power cord if it is bundled or tangled

Do not use the power cord if it is bundled or tangled. If it is used in this manner, it can overheat and fire may be caused.

Do not process, bend, wring, or stretch the power cord forcibly

Do not process, bend, wring, or stretch the power cord forcibly. Fire or electrical shock may result.

Perform periodic check

Check the device frequently. Do not leave the dust and dirt on the wiring terminals and electrical components. A fire disaster may result in.

Substances that can not be used

Never use explosive substances, flammable substances and substances that include explosive or flammable ingredients in this unit. Explosion or fire may occur. (Refer to page 71 "19. List of Dangerous Materials".)

Do not disassemble or modify this unit

Do not disassemble or modify this unit. Fire or electrical shock or failure may be caused.

2.Cautions in Using with Safety

Fundamental Matters of "WARNING!" and "CAUTION!"

CAUTION!

During a thunder storm



During a thunderstorm, turn off the power key immediately, then turn off the circuit breaker and the main power. If this procedure is not followed, fire or electrical shock may be caused.

When electric power failure occurs...

The device stops operation when electric power failure occurs. In this case, turn off the breaker for safety. When the power is applied again, if the power switch is turned on, the main unit will go to automatically upper step.

3. Before Using This Unit

Requirements for Installation

WARNING!

1. Always ground this unit



- Be sure to connect the ground wire to the earth conductor or earth terminal to prevent accidents caused by an electric shock.



- Do not connect the earth wire to gas or water pipes. If not, fire disaster may be caused.
- Do not connect the earth wire to the ground for telephone wire or lightning conductor. If not, fire disaster or electric shock may be caused.
- Consult your local electrical contractor for power connecting work.

2. Choose a proper place for installation



- Do not install this unit in a place where:
 - ◆ Rough or dirty surface.
 - ◆ Flammable gas or corrosive gas is generated.
 - ◆ Ambient temperature above 35°C.
 - ◆ Ambient temperature fluctuates violently.
 - ◆ There is direct sunlight.
 - ◆ There is excessive humidity and dust.
 - ◆ There is a constant vibration.
 - ◆ Without a ventilation system.
 - ◆ The unstable place of a power supply.



- Make sure that no flammable substances are placed around the devices. Keep space as shown, at least, in the figure below. We recommend the installation inside the ventilation system such as a draft chamber.

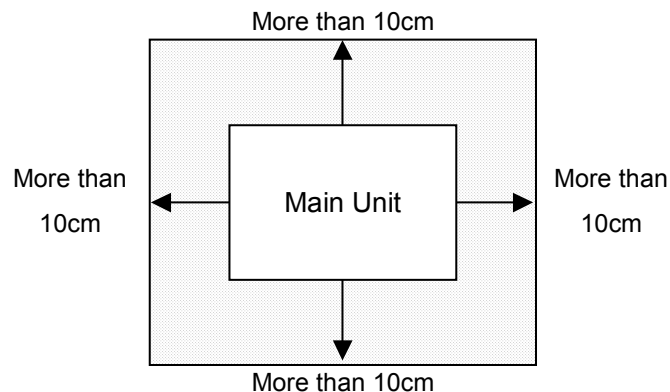

3. Do not use this unit in an area where there is flammable or explosive gas



- Never use this unit in an area where there is flammable or explosive gas. This unit is not explosion-proof. An arc may be generated when the power switch is turned ON or OFF, and fire/explosion may result.
- To know about flammable or explosive gas, refer to page 71 "19. List of Dangerous Materials".

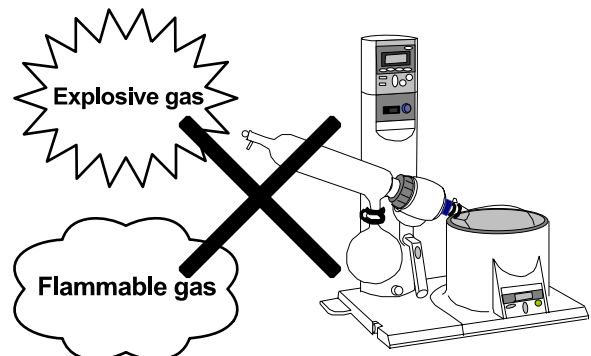

3. Before Using This Unit

Requirements for Installation

4. Install exhauster and ventilator



- Be sure to install an exhauster, ventilator and extinguisher around the device.
The oily smoke of silicone oil generated by heating is flammable and may cause fire disaster. Silicone oil also may generate harmful gas when it reaches a high temperature.

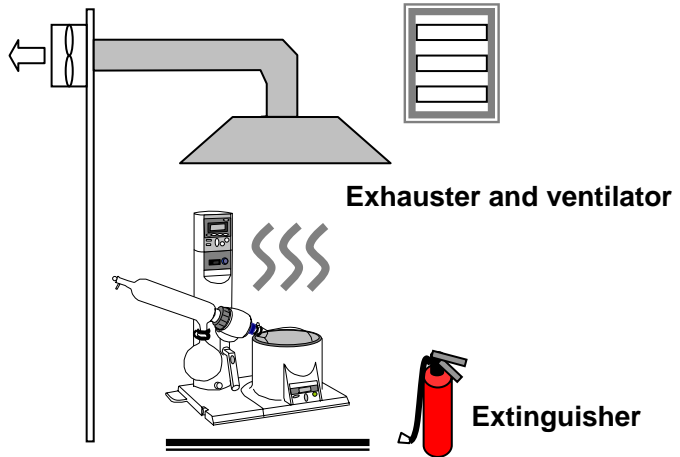

CAUTION!

5. Do not modify



- Modification of this unit is strictly prohibited. This could cause a failure.

Modification

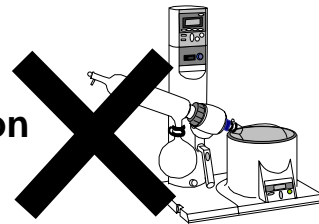

6. Installation on horizontal surface



- Place this unit as flat a place as possible. If the three rubber feet and adjuster are not in uniform contact with the floor surface, noise or vibration may result. Additionally, the unit may cause a problem or malfunction.

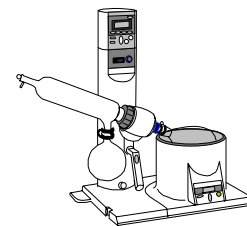

7. Choose a correct power distribution board or receptacle



- Choose a correct power distribution board or receptacle that meets the unit's rated electric capacity.

Electric capacity: RE601/RE801: 1.5A at AC100V to AC240V

Electric capacity for RE main unit (except water bath or oil bath) and vacuum controller. The water bath or oil bath uses the other power source. The electric capacity of 12.5A and 6.5A are required for the BM500/BO400 and BM510/BO410 models respectively.

NOTE)

The device adopts the free power system for AC100V to AC240V. The RE main unit includes the switching power source, the secondary power source of which is driven with DC24V. Do not connect the lines that share the power source, or do not place the appliances that generate noise around the device. A malfunction may occur on the device.

3. Before Using This Unit

Requirements for Installation

8. Before/after installing



- It may cause injury to a person if this unit falls down or moves by the earthquake and the impact. etc..To prevent, take measures that the unit cannot fall down, and not install to busy place.
- Be sure to install an exhauster, ventilator and extinguisher around the device.

9. Handling of power code



- Do not entangle the power cord. This will cause overheating and possibly a fire.
- Do not bend or twist the power cord, or apply excessive tension to it. This may cause a fire and electrical shock.
- Do not lay the power cord under a desk or chair, and do not allow it to be pinched in order to prevent it from being damaged and to avoid a fire or electrical shock.
- Keep the power cord away from any heating equipment such as a room heater. The cord's insulation may melt and cause a fire or electrical shock.



- If the power cord becomes damaged (wiring exposed, breakage, etc.), immediately turn off the power at the rear of this unit and shut off the main supply power. Then contact your nearest dealer for replacement of the power cord. Leaving it may cause a fire or electrical shock.
- Connect the power plug to the receptacle which is supplied appropriate power and voltage.

10. Precautions for use of sample including organic solvent



- Note the followings when using the sample which includes organic solvent.
 - ❖ A Teflon seal, which is sold separately, is recommended for the seal on the rotary joint.
 - ❖ A Teflon diaphragm model vacuum pump is recommended.
 - ❖ A Teflon solenoid valve, which is sold separately, is recommended for the vacuum controller.
 - ❖ The SUS316 pressure sensor, which is sold separately, is recommended for the vacuum controller.

Cautions

Use the optional Teflon vacuum seal for ketone and an ether system solvent.

Acetone, methyl ethyl ketone, methyl isobutyl ketone, ethyl ether, and MTBE (methyl t-butyl ether) etc. -- the case where ketone and an ether system solvent are used -- vacuum seal (NBR) of standard attachment It will swell.

Use the fluorocarbon polymers vacuum seal of an option.

ORE80



VR type Teflon solenoid valve

ORE70



Teflon vacuum seal

ORE90



VR type pressure sensor for organic solvent

PG200 model



Teflon diaphragm model vacuum pump

4. Outside Appearance

RE601/801 model installation

RE601/801

Front view

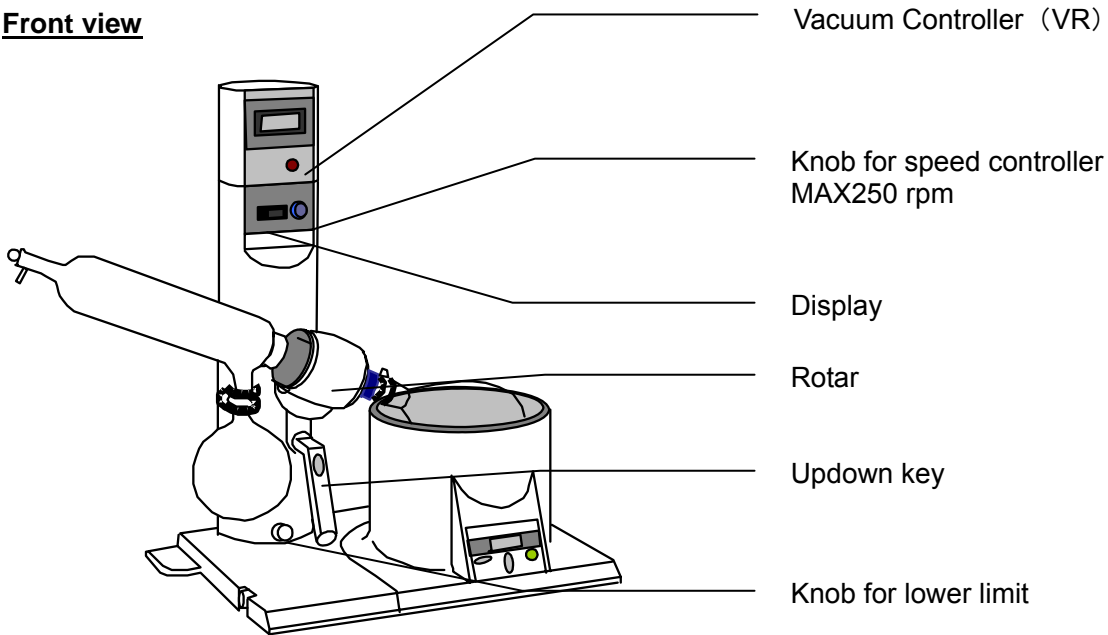

Rear view

Vacuum Controller(VR)

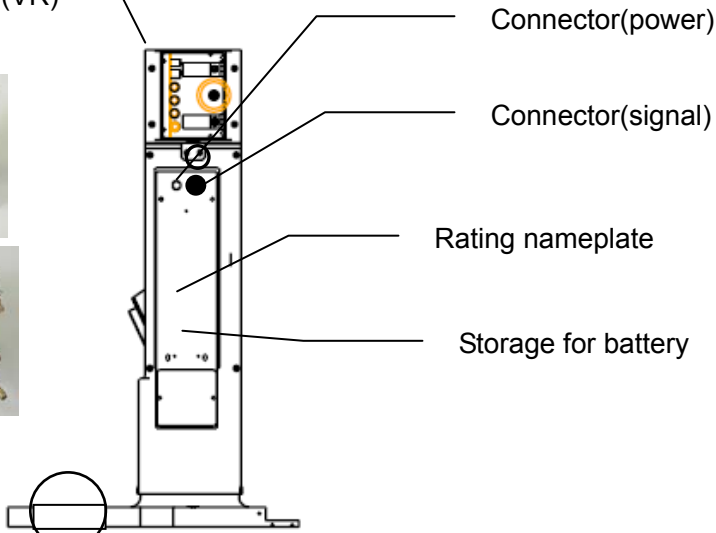

Socket for power supply

Circuit breaker

4. Outside Appearance

Vacuum Controller

Front view



Control panel

Rear view

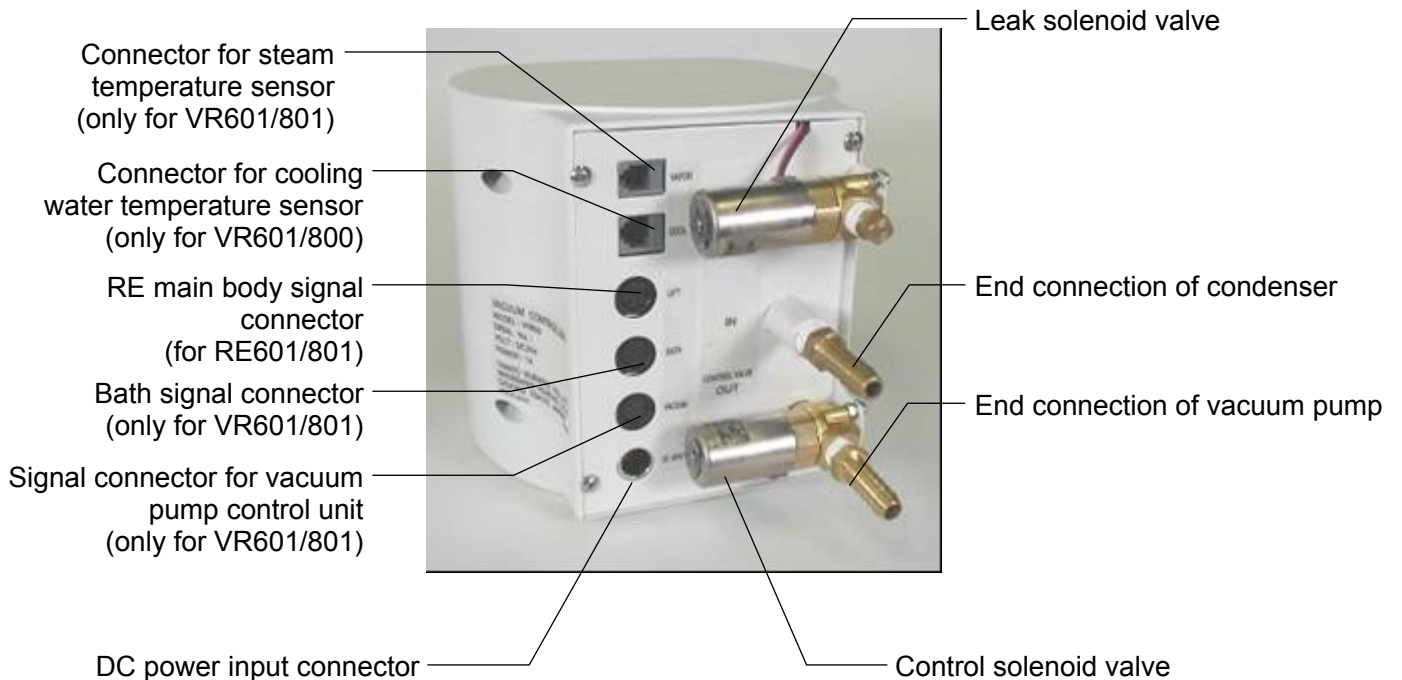

Connector for steam temperature sensor (only for VR601/801)

Connector for cooling water temperature sensor (only for VR601/800)

RE main body signal connector (for RE601/801)

Bath signal connector (only for VR601/801)

Signal connector for vacuum pump control unit (only for VR601/801)

DC power input connector

Leak solenoid valve

End connection of condenser

End connection of vacuum pump

Control solenoid valve

5. Installation Method

RE601/801 model installation

1. RE installation

Unpack the main unit of RE601/801 and install it on the level area.

RE601/801 model installation

Refer to the instruction manual of vacuum controller for the installation of VR601/801 model vacuum controller.

Connect the VR601 model vacuum controller and VR801 model vacuum controller to the RE601 model and RE801 model respectively.

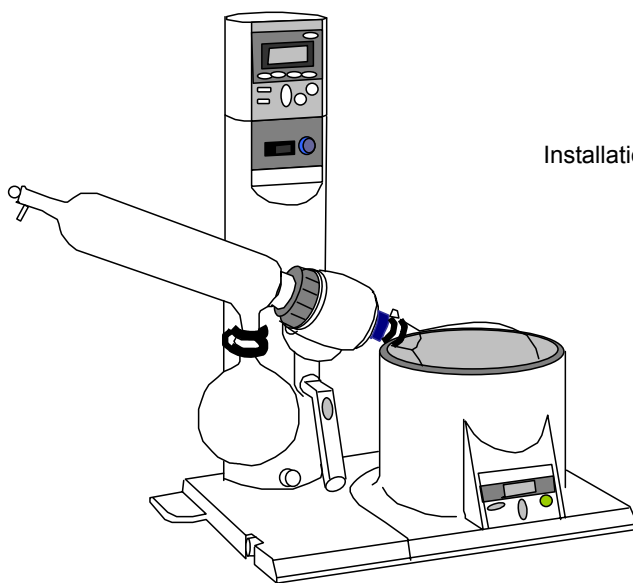

Connection on back surface area

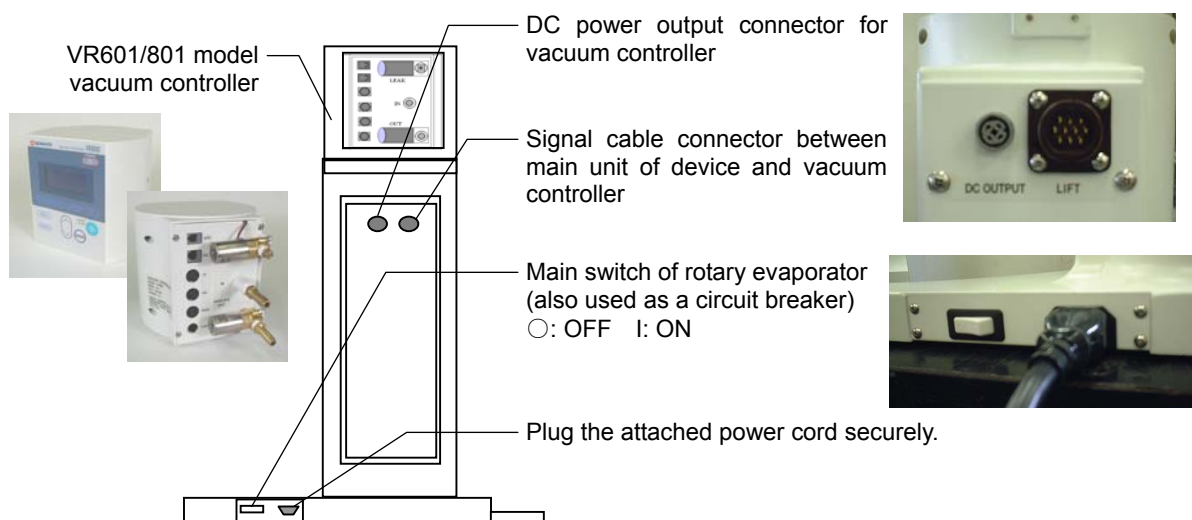

Connect a vacuum hose and a cooling hose to the cooling water circulation unit.

A vacuum hose should prepare the inside diameter of 6mm, and a cooling hose should prepare a thing with an inside diameter of 9mm.

Pipe by the length that each hose between a vacuum pump or the cooling water circulation unit is not pulled at the time of a main part lift rise.

Refer to P.21 for a piping configuration.

5. Installation Method

Installation Method

1. RE601/801 back surface (battery attachment)

Battery: Two 9V alkaline dry cells (accessories)

- ① Remove the screw of a back surface and remove a battery attachment plate lid.
- ② Attach 9V alkaline dry cell to a back battery storage part.
- ③ Set polarity correctly.
- ④ Attach a battery attachment plate lid with the screw.

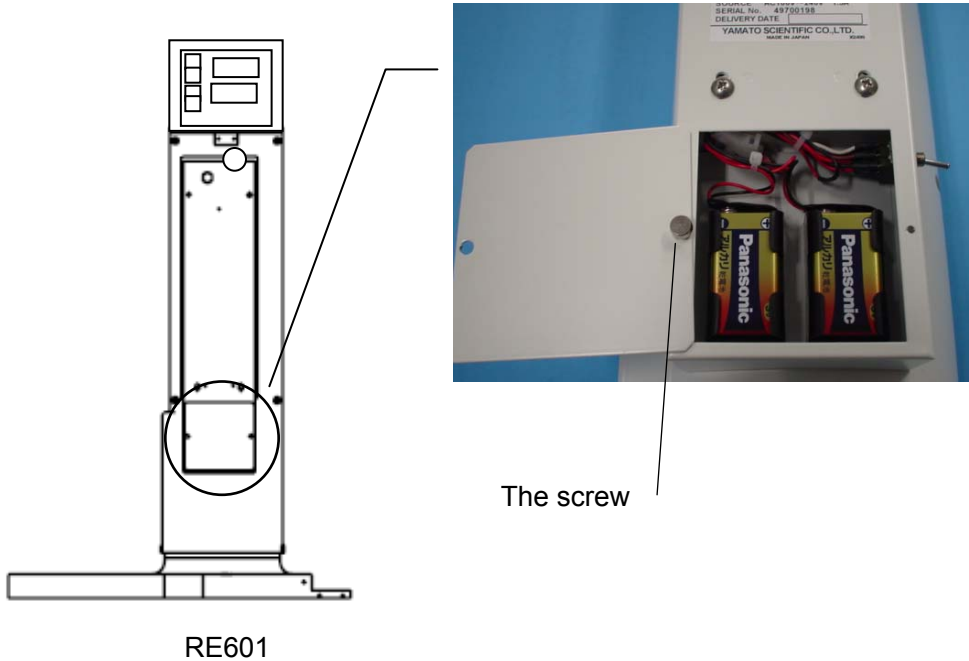

CAUTION!

- Confirm the polarity of the electrode.
- When an electrode is connected in the opposite direction, a problem occurs, and dangerous.
- Don't mix the different kind of battery .
- Remove a battery when you don't use for a long time.

5. Installation Method

Installation Method

2. Attachment of Bath ways

- 1) The base of a main part is lifted so that the bottom can be seen.

The base of a main part



- 2) An attached bath guide is inserted in a groove portion.

Bath ways



Groove portion

- 3) Return a main part and use it as a standard of bath installation.

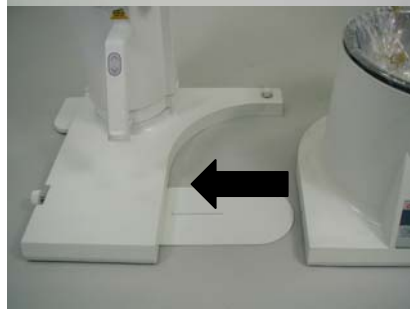

5. Installation Method

Installation Method

3. Connection of RE Main unit and vacuum controller (VR)

1) Fixation of VR vacuum controller (VR)

Unpack the device and install it at level area.

- ① Tear the seal from screw hole of RE main unit.

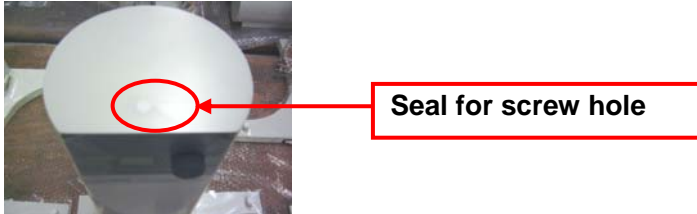

- ② Cover RE main unit by the Bracket vacuum controller.

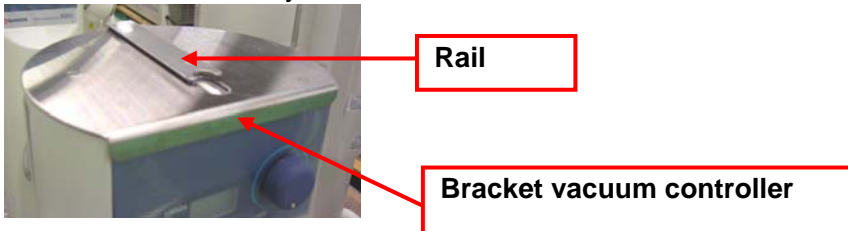

- ③ Fix the Bracket vacuum controller by flat head screw (M4) and tapping screw (M4).

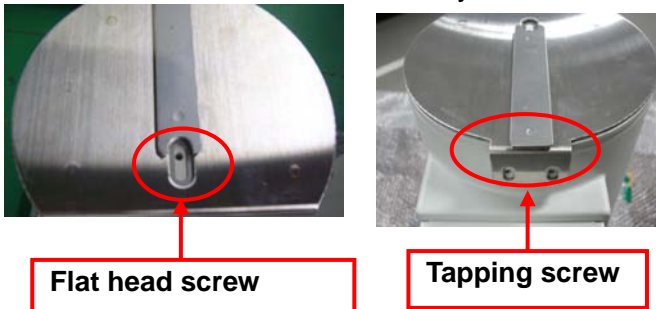

- ④ Slide the VR main unit that fixing ditch of VR with the rail of Bracket vacuum.

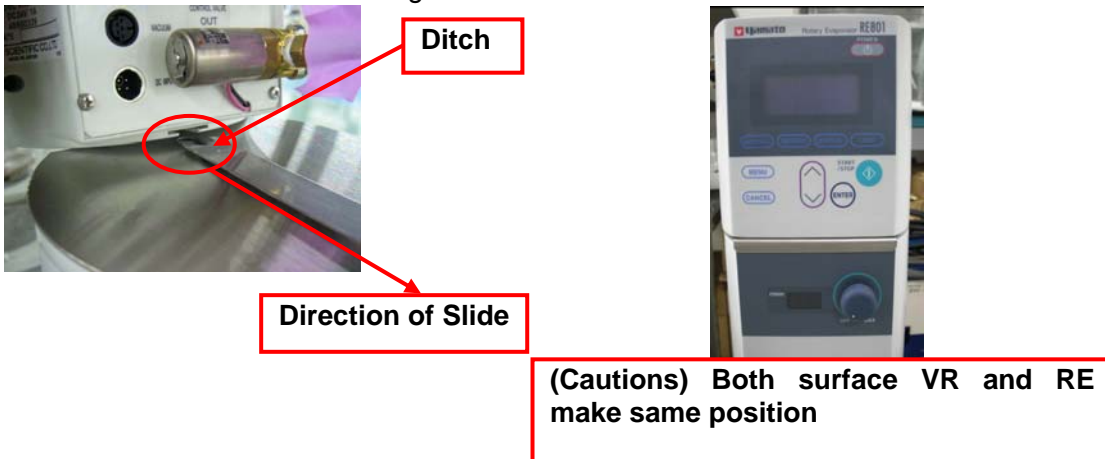

* When there are detached, do the above procedure from 4 to 1.

5. Installation Method

Installation Method

2) Connection between VR601/801 vacuum controller and RE601/801 main unit/bath

Connect the lead wire with a connector attached to the vacuum controller to the connector.

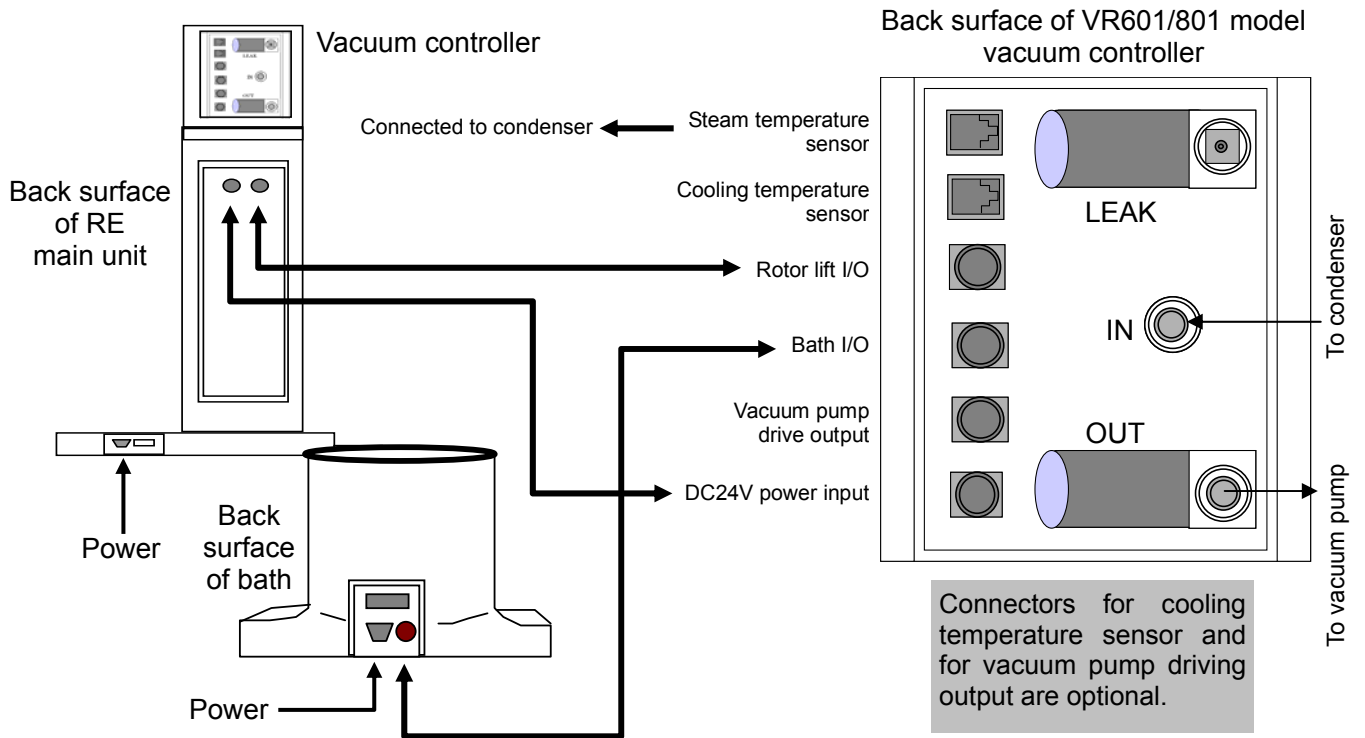

5. Installation Method

Installation Method

4. Harness connection

Use the exclusive harness to connect the respective harness.

1) Evaporating temperature sensor/cooling temperature sensor (RE601/801 model option)

The configuration of connector end to the VR at the cooling temperature sensor on the RE601/801 option differs from that at the evaporating temperature sensor even they have the same shape. It, therefore, can not be used as a cable of evaporating temperature sensor.

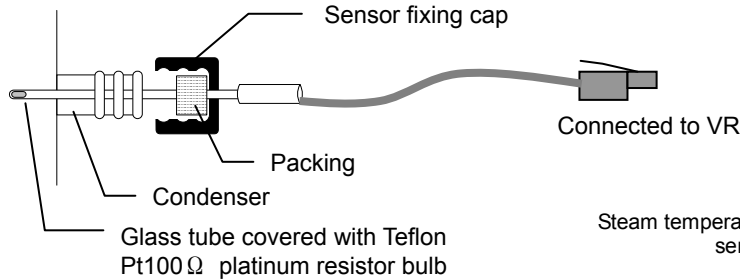

2) Rotor lift I/O harness

This harness controls the operation of device or abnormality at error occurrence by interfacing with the RE main unit using the signals.

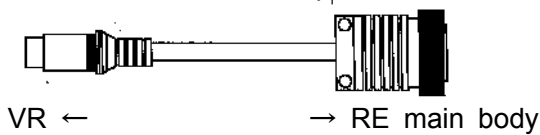

Steam temperature sensor
Cooling temperature sensor
Rotor lift I/O
Bath I/O
Vacuum pump drive output
DC24V power input

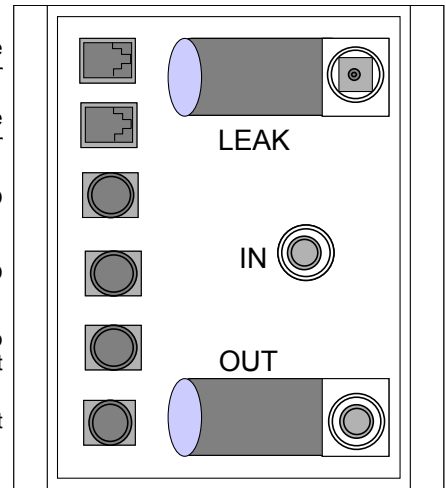

3) Bath I/O harness

This harness connects the RE601/801 model and bath to control the auto stop of bath, heat-retention and abnormality at error occurrence

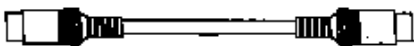

4) Vacuum pump driving output harness (attached to the optional relay box)

This harness connects the RE601/801 model and vacuum pump control relay box to turn on/off the vacuum pump or delay stop the pump when the main body stops.

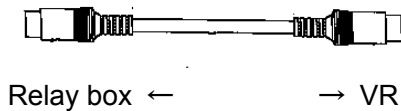

5) DC24V power harness

This harness supplies the DC24V power from the RE main body to the VR model vacuum controller and TA300 model evaporating temperature indicator.

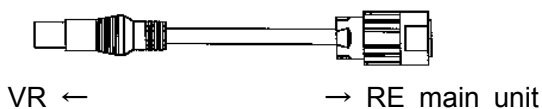

6) Power cord

The power cord attached to the RE main unit is plugged into the connector on the back surface of main unit to connect to the power receptacle.

Installation Method

5. Connecting method and assembling procedures of glass unit

1) Glass set on condenser

Connect the glass set to the rotor unit on the RE main unit.

A set

Photo: RE601AW

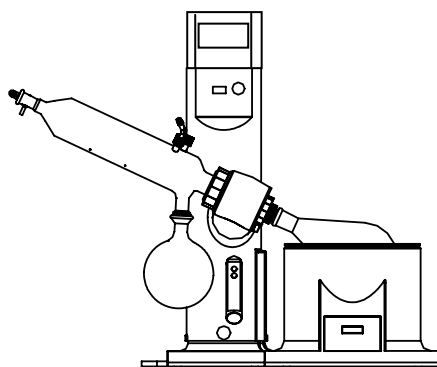

Glass set A:

The standard glass set, where the condenser is tilted to be set, suitable for distillation, concentration, and collection of samples.

B set

Photo: RE601BW

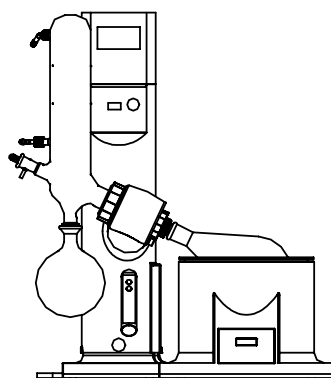

Glass set B:

The condenser is set vertically, suitable for distillation, concentration, and collection of samples regardless of their boiling point. The condenser unit and connecting pipe is integrated to realize the space-saving design. The connecting pipe is also equipped with a unique drip-proof mechanism.

C set

Photo: RE601CW

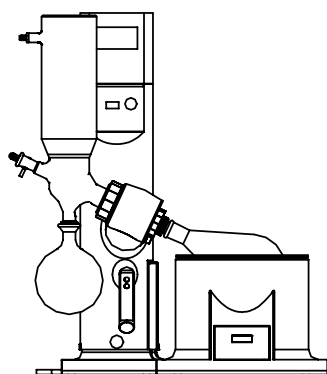

Glass set C:

The condenser is set vertically, suitable for distillation, concentration, and collection of samples which has a low boiling point, such as dry ice or ice. The condenser unit and connecting pipe is integrated to realize the space-saving design. The connecting pipe is also equipped with a unique drip-proof mechanism.

5. Installation Method

Connecting method and assembling procedures of glass unit

2) Connecting method and assembling procedures of glass unit①

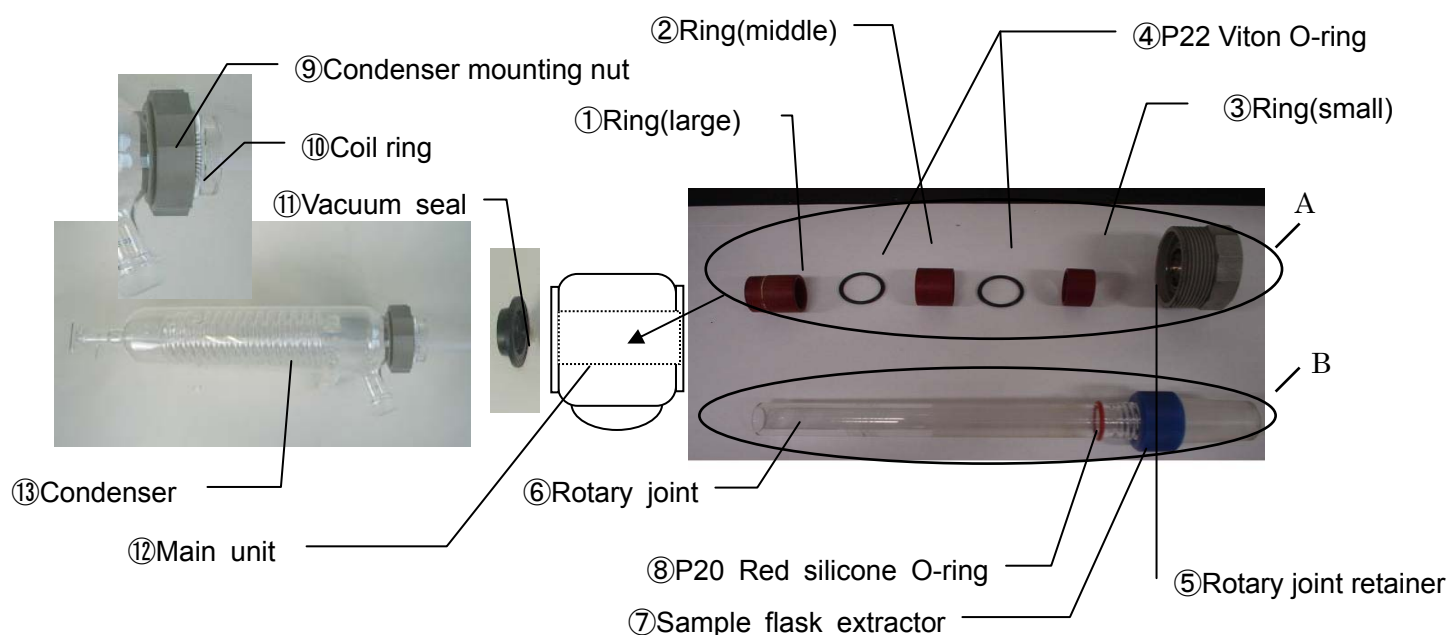

[1]How to fix the rotary joint

It is inserted into ①Ring(large)→ ④P22 Viton O-ring→ ②Ring(medium)→ ④P22 Viton O-ring→ ③ Ring(small), and it clings in the order of ⑤Rotary joint retainer in the main unit rotar part. (Figure A part)

Figure B part has a glass set attached.

1. ⑤Rotary joint retainer is relaxed.



2. ⑥Rotary joint is inserted. (Though it is possible to insert the ⑥Rotary joint any position ,it is recommended checking ⑧P20 Red silicone O-ring at the tip of ⑤Rotary joint retainer.)

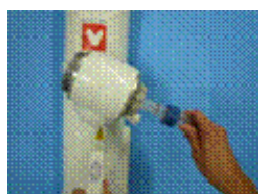

3. ⑤Rotary joint retainer is tightened after ⑥Rotary joint is inserted.

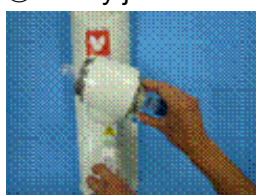

5. Installation Method

Connecting method and assembling procedures of glass unit

[2] How to fix a Condenser

- ① It is passed through the condenser in order of ⑬It prepares for the condenser, in rotor installation part ⑨Condenser fixing nut → ⑩Coil ring.
- ② Apply a thin layer of silicone grease onto the mating surface with ⑥rotary joint on the ⑪Vacuum seal and fit it into the fitting area of condensation tube with the orientation shown in the figure. Insert the seal into the rotary joint together with the condensation tube and tighten it with the condenser fixing nut.

Cautions

- i . Use an optional Teflon vacuum seal for ketone and an ether system solvent.
Acetone, methyl ethyl ketone, methyl isobutyl ketone, ethyl ether, and MTBE (methyl t-butyl ether) etc.
-- the case where ketone and an ether system solvent are used -- vacuum seal (NBR) of standard attachment It will swell.
Use the fluorocarbon polymers vacuum seal of an option.
- ii . Be careful of the glass damage.
- iii . Carry out assembling in the order of [1] [2].
When [2] is fixed first, it sometimes becomes a problem cause such as vacuum omission.

5. Installation Method

Connecting method and assembling procedures of glass unit

2) Connecting method and assembling procedures of glass unit②

Setup of the sample-receiving flask (round-bottom flask) and distillation flask (recovery flask).

Apply a thin layer of silicone grease onto the facing surface as necessary and fix them with the attached clamp.

Sample-receiving flask



Flask clamp (2)

Distillation flask



Flask clamp (1)

*

*

* In using 2L flask of an optional (the distillation flask and the sample-receiving flask), use the metal clamp of an optional respectively. Moreover, by the load of a repeated load, since there is a possibility of damaging, use the resin clamp as a consumption article (P. 70~71 references)

Setup of sample induction cock

Insert the sample induction cock with Teflon tube into the connecting pipe. Apply a thin layer of silicone grease onto the facing surface as necessary.

Sample induction cock (Teflon tube attached)



Nozzle · Cap for nozzles · Packing for nozzles



5. Installation Method

Connecting method and assembling procedures of glass unit

3) Piping method

Piping between condenser and peripheral device

The rotary evaporator requires the vacuum equipment such as vacuum pump or aspirator, cooling water circulation system to cool the condenser, and tap water. Use the vacuum hose with the inner diameter of 6mm for vacuum route and heat insulation hose with the inner diameter of 9mm for cooling route. Securely fix the connection between respective hoses and resin nipple using a clamp.

Piping between RE601/801 and glass set condenser

Piping method to glass set A condenser

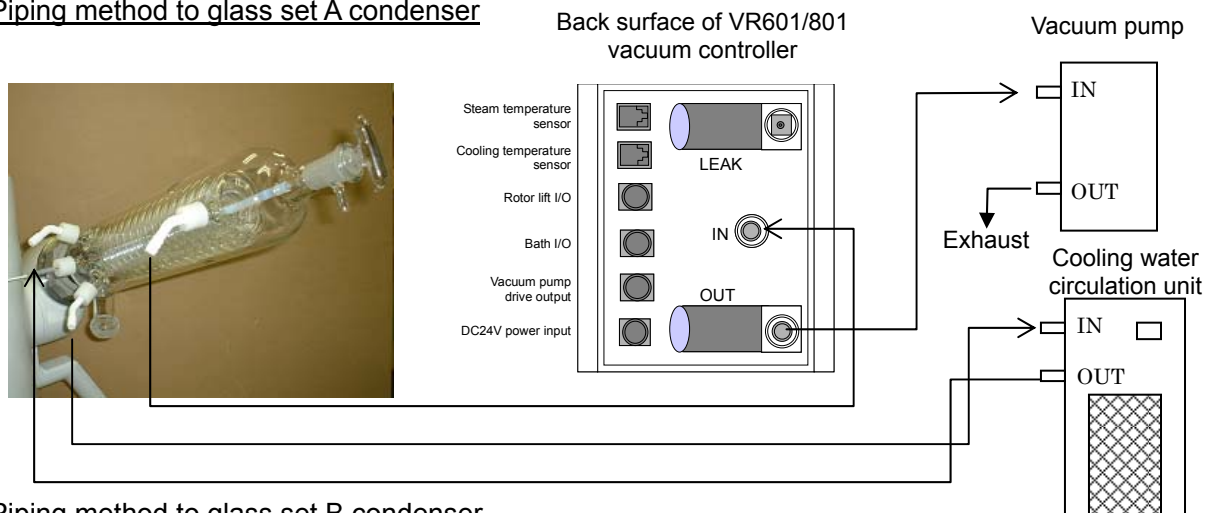

Piping method to glass set B condenser

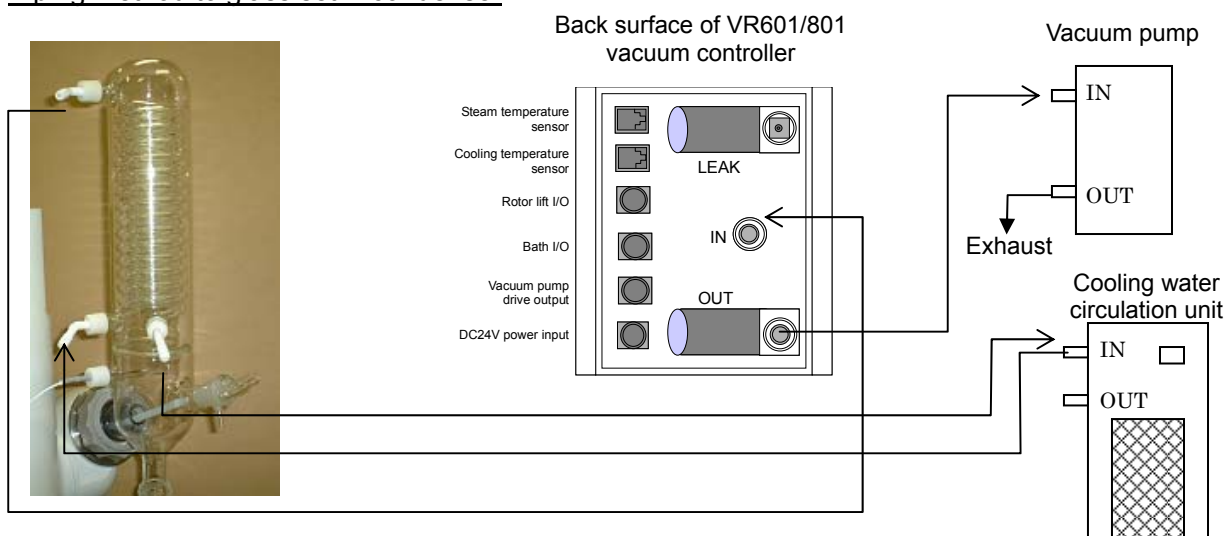

Piping method to glass set B condenser

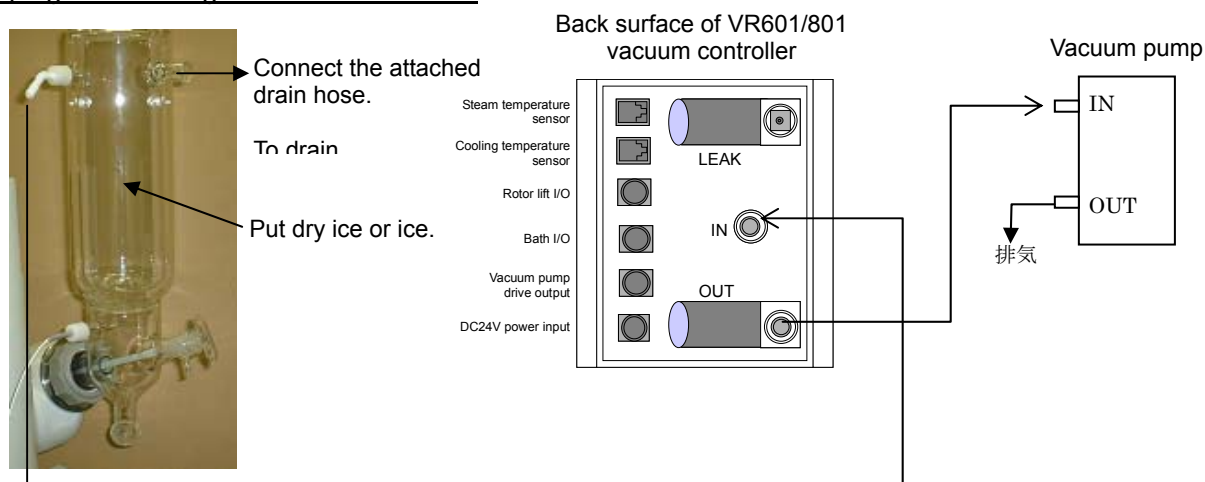

5. Installation Method

Installation Method (Optional accessories)

4) Optional accessories and their connection method

Optional accessories for rotary evaporator include RT101/200 model solvent collection device, CF720, CF750 type cooling water circulation unit, vacuum pump control unit for RE601/801, which enables automatic operation of vacuum pump, relay hose connection fitting used on the vacuum hose or cooling water circulation hose, and glass trap to prevent back-flow.

No.	Name	Model	Applicable model	
			RE601	RE801
①	RT101 model solvent collection device	RT101	○	○
②	RT200 model solvent collection device	RT200	○	○
③	CF720 and CF750 type cooling water circulation unit	CF720/750	○	○
④	Hose connection fitting	ORE30	○	○
⑤	Vacuum pump control unit (RE601 / for 801)	ORE60	○	○
⑥	Glass trap	ORE40	○	○

4) Optional accessories and their connection method①

① RT101 model solvent collection device

Refer to the RT101 model instruction manual for the connection method.

② RT200 model solvent collection device

The device consists of glass condenser and 500 milliliter collection flask. The device requires a cooling water circulation unit.

Connect the vacuum hose between the exhaust nozzle of vacuum pump and IN nipple on the RT200, as shown in the figure. The end connection of exhaust piping and cooling water piping on the RT200 model are placed on the back surface of main unit.

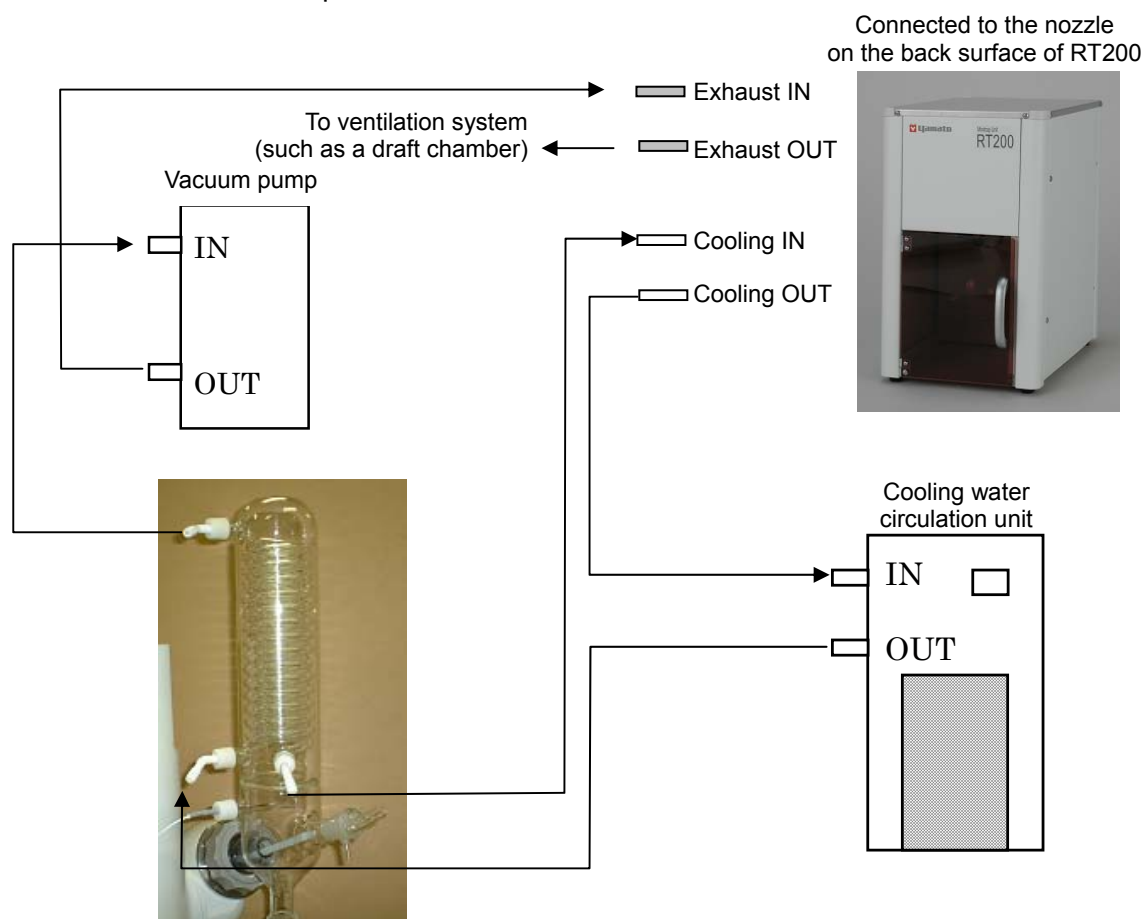

5. Installation Method

Installation Method (Optional accessories)

4) Optional accessories and their connection method②

③CF720 and CF750 type cooling water circulation unit

The internal piping of the unit has with two discharge ports and allows cooling in two systems(two external units).

- Carefully check the connecting piping before use.

※About the circulation pump switch

The circulation pump switch can be operated alone free of relations with the temperature controller.

Turn the breaker on, check that proper circulation is made in each pipe and that the unit is not operating with no-load, and then turn the switch "On".

When circulation is not necessary, not only close the both cocks but also turn the switch "Off" to prolong the pump life.

※Operation and indicated data is for when only one side is used (one system is connected).

Note that the flow and the lift might decrease when both sides are used (two systems are connected) compared with when only one side is used.

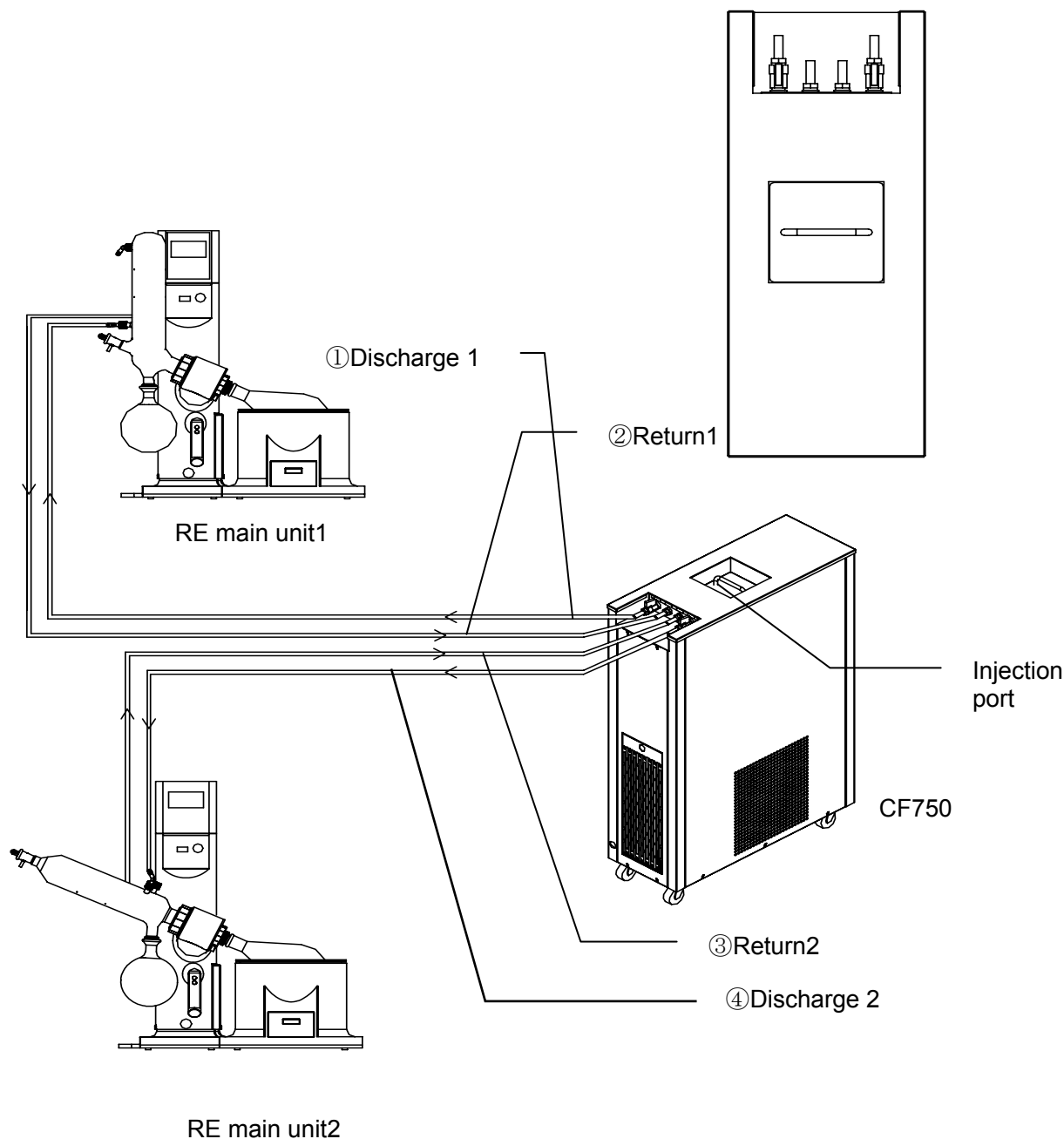

5. Installation Method

Installation Method (Optional accessories)

4) Optional accessories and their connection method③

④ Piping hose connection to hose connection fitting

The nipple-fitting is used to reduce the load of vacuum hose and cooling water circulation hose, which are connected to the condenser unit on the RE main unit, at the operation of lift by supporting them.

Refer to the instruction manual of hose connection fitting for the connection method.

⑤ Connection of vacuum pump control unit for RE601/801

When the vacuum pump is connected to the RE601/801, the unit has the function that turns on/off the power of vacuum pump interlocking with the start/stop of RE main unit. It also has the function that operates the pump for three minutes after the operation end of RE main unit to exhaust the residue inside the vacuum route by auto cleaning function which is integrated into the vacuum controller.

Front view



Manual/auto switch
Outlet to connect pump

Rear view



RE connection cable
Connected to the
vacuum controller
Power cord plug-in connector

⑥ Connection example of glass trap

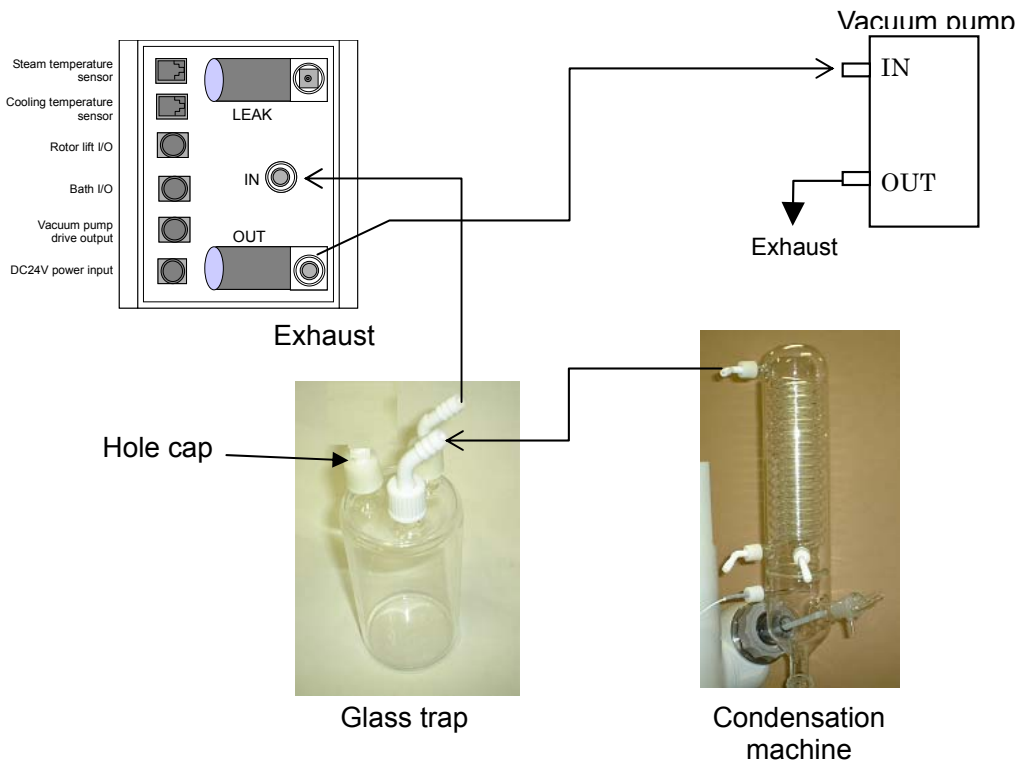

6. Control Panel

Control Panel (Main unit)

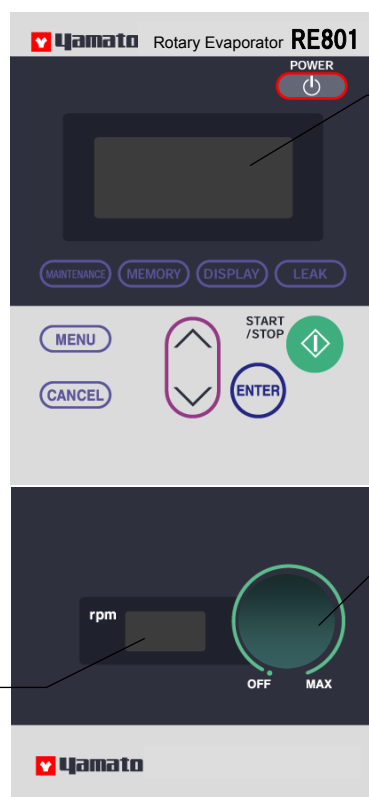

① The following page is referred to

② Rotation control knob

③ Liquid crystal rotation indicator

• The RE601/801 model includes respectively the VR601/VR801 vacuum controller as standard equipment.

No.	Name	Function
②	Rotation control knob	The control knob equipped with the rotary motor ON/OFF switch. Clockwise rotation : Acceleration Counterclockwise rotation : Slowdown ---The condition of "OFF"--- The rotation of the motor stops when the knob is turned counterclockwise until with a clink. Factory setting, it is shipped in the state of "OFF." Maximum rotation speed: 250 rpm
③	Liquid crystal rotation indicator	The indicator digital displays the rotation speed. It indicates the abnormality state when overload in motor occurs.

6. Control Panel

Control Panel (Vacuum Controller)

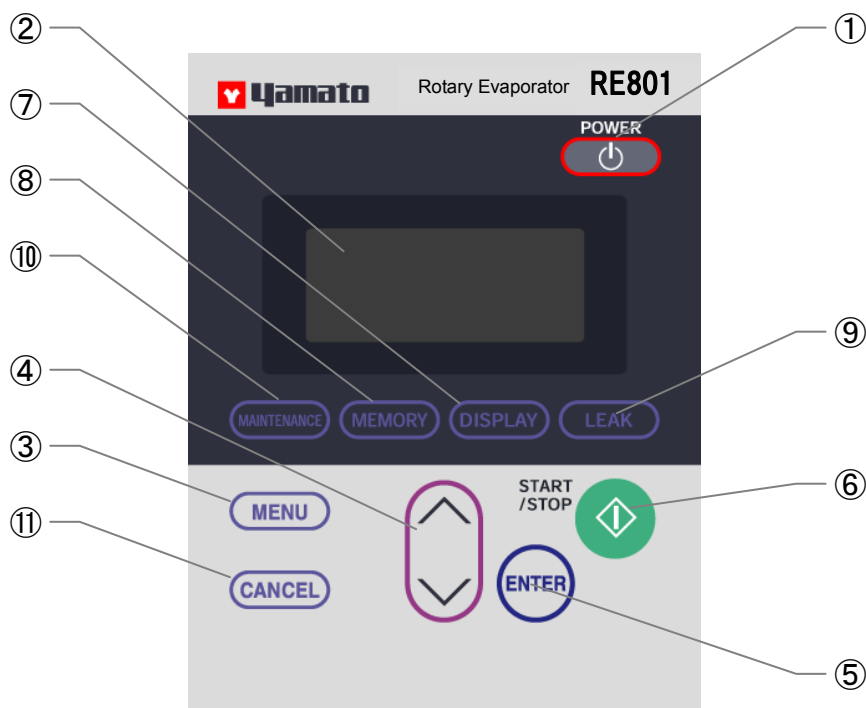

• The layout of operating panel on the VR601/VR801 vacuum controller is the same as the Photo above.

No.	Name	Function
①	POWER key	Turns on/off the vacuum controller.
②	LCD screen	Displays the information about setting and operation of device in Kanji or alphabetical characters.
③	MENU key	Used to select the operation mode.
④	Up/down key	Changes the preset value and setting items.
⑤	ENTER key	Determines the setting value and setting items after they are changed.
⑥	START/STOP key	Starts/stops the operation.
⑦	DISPLAY key	Shifts the LCD screen or changes the display style.
⑧	MEMORY key	Memorizes/call the information about operation mode setting. The VR300 vacuum controller does not have this key.
⑨	LEAK key	Controls the vacuum pressure during operation. The leak valve is opened while this key is pressed.
⑩	MAINTENANCE key	Used to specify the details of operation and display, or to check the error log.
⑪	CANCEL key	Cancels the incorrect input.

7.Operation Function

Basic Operation

Flow of Basic Operation

The operation procedure of rotary evaporator is described below.

- ① Set the desired bath temperature and heat the bath until the bath temperature becomes stable.
- ② Turn on the switch of Cooling water circulation unit and circulate the cooling water.
- ③ Make sure that the rotation control knob is fully turned to the left (rotation OFF). Turn on the power switch (1 position) on the back surface of RE main unit.
- ④ Put the moderate amounts of sample into the distillation flask and connect it to the rotary joint.
- ⑤ Turn on the switch of Vacuum pump and decompression.
- ⑥ Set the desired rotation speed with the rotation control knob and then start the operation by the key operation on the VR model vacuum controller.

(Cautions: Although number of rotations is displayed from 14rpm, when using it, please use it at 20rpm or more.)

- ⑦ Lower the sample flask using the lift ∇ (down) key to heat it.

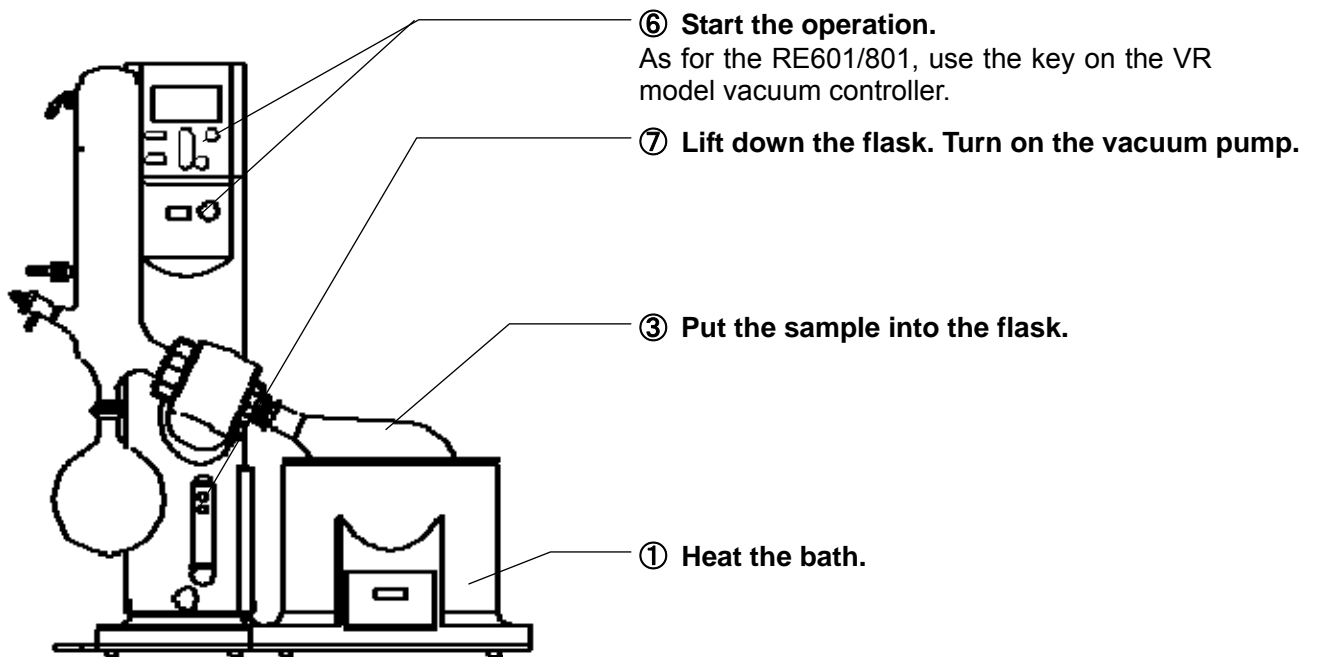

7.Operation Function

Basic Operation

Flow of Basic Operation (Vacuum Controller)

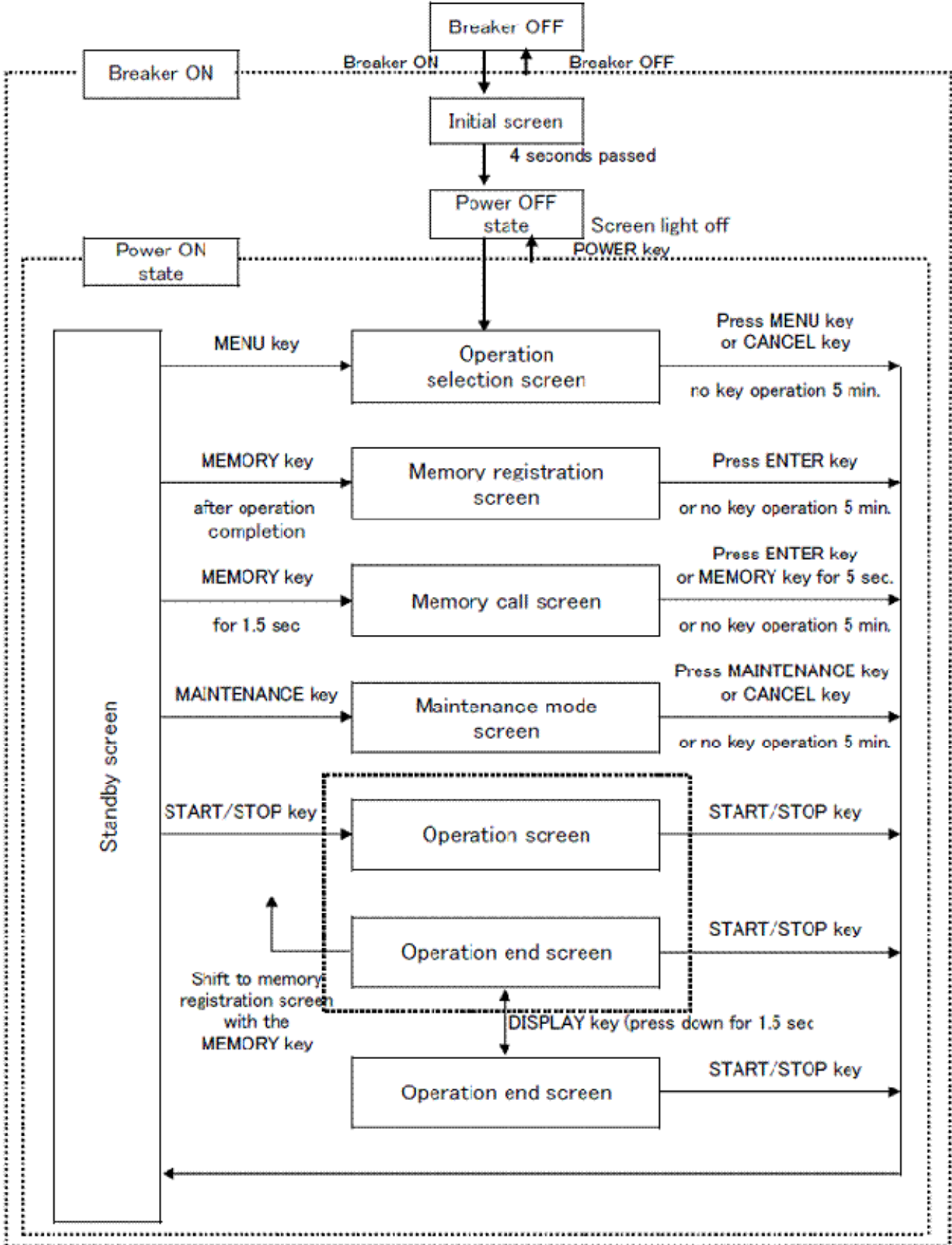

7.Operation Function

Operational Function for Vacuum Controller

No.	Operation Mode	RE601	RE801
1	Free operation	○	○
2	Fixed temperature operation	○	○
3	Fixed temperature timer operation	○	○
4	Descending operation	○	○
5	Descending timer operation	○	○
6	Automatic operation I (auto operation with continuous drying)	×	○
7	Automatic operation II (auto operation for distillation of single solvent)	×	○

1. Free operation	Select this mode when the operation does not require the vacuum controller or when canceling the operation mode which requires it. In the free operation mode, the control solenoid valve remains open and vacuum control is not performed.
2. Fixed temperature operation	Select this mode when performing continuous operation with the preset vacuum pressure.
3. Fixed temperature timer operation	Select this mode when stopping the fixed temperature operation automatically at the preset time. The setting range of fixed temperature timer is 1 to 999 (unit: minute).
4. Descending operation	Select this mode when gradually lowering the degree of vacuum to the operating vacuum pressure.
5. Descending timer operation	Select this mode when stopping the descending operation automatically at the preset time. The setting range of descending timer is 1 to 99 (unit: minute). The setting range of fixed temperature timer is 1 to 999 (unit: minute).
6. Automatic operation I (auto operation with continuous drying)	This mode is exclusive to the RE801 model. Select this mode when performing automatic distillation and drying. The device automatically sets the operating pressure (vacuum pressure) only by setting the evaporating temperature. The device automatically sets the operating pressure (vacuum pressure) only by setting the evaporating temperature. The timer function which extends the drying time can be added. The setting range of timer is 1 to 999 (unit: minute).
7. Automatic operation II (auto operation for distillation of single solvent)	This mode is exclusive to the RE801 model. Select this mode when distilling the single solvent sample automatically.

7.Operation Function

Key Functions and Operations

LCD display	It displays all information about setting and operation of the device. They are displayed in Kanji/Katakana or alphabetical characters, switchable using the display switching function.
MENU key	This key selects the operation mode. The eight operation modes listed in the previous page are displayed. The operation menu varies depending on the mode selected. Press the MENU key. Select the desired operation menu with the ▽ key. Press the ENTER key to display the condition setting screen of respective operation menu.
△▽ (up/down) keys	This key changes the preset value or selects the desired function.
ENTER key	This key determines the input value and selected function.
CANCEL key	This key cancels the determined value or function. Press this key for few seconds to minimize the setting value.
START/STOP key	This key starts the operation. It stops the operation when pressed again.

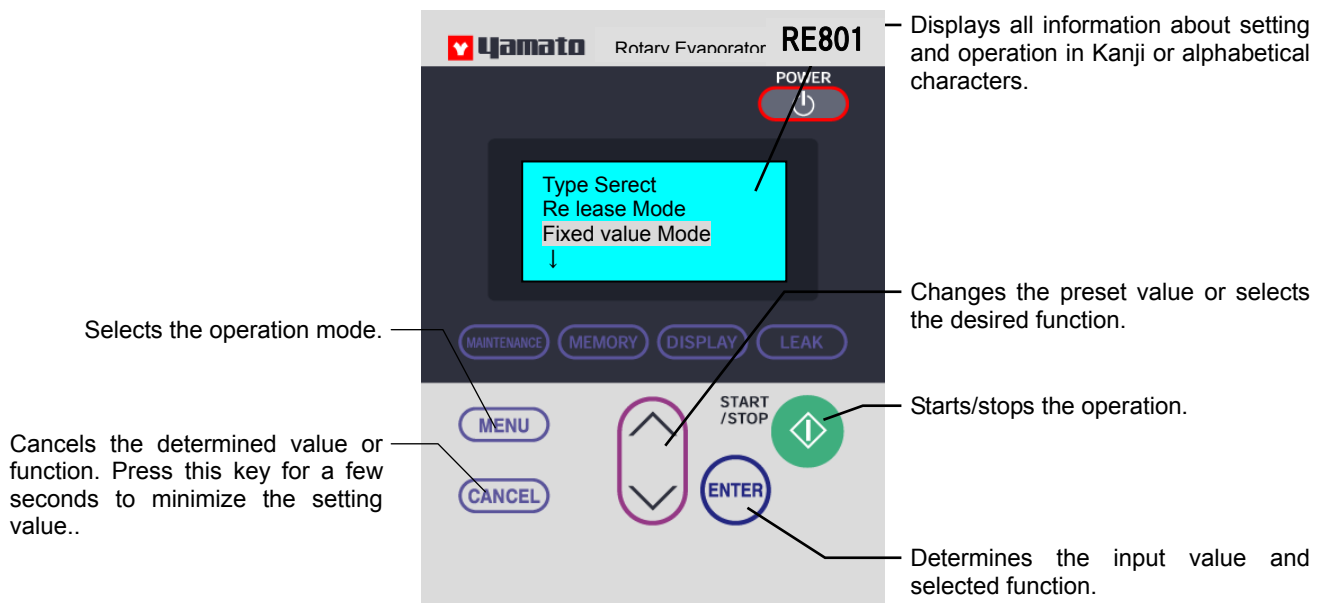

7.Operation Function

Key Functions and Operations

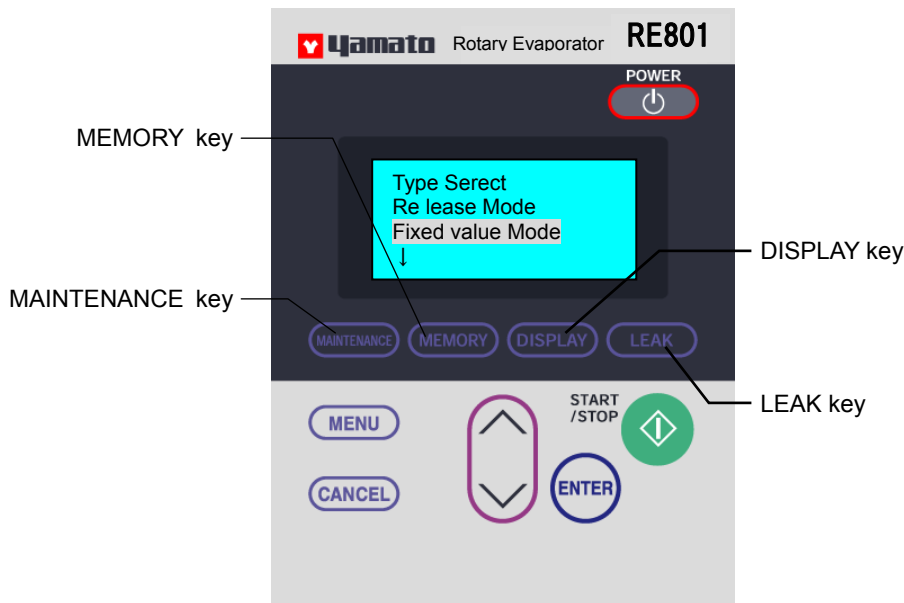

LEAK key

The leak solenoid valve is opened to increase the low degree of vacuum while this key is pressed during operation.

DISPLAY key

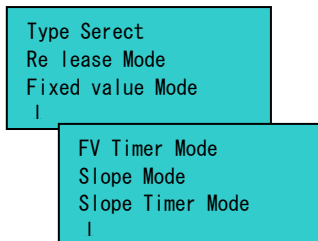

This key shifts the LCD screen or changes the display at operation to the graphic style.

Move the digit with the DISPLAY key or Δ / ∇ key to check the preset value or indicated value at the setting of value or operation. Press this key for few seconds to graphic display the operational state during operation or on the operation completion screen. The display changes to the graphic display and the process under operation blinks. The current measured pressure and measured steam temperature are also displayed on the screen.

MEMORY key

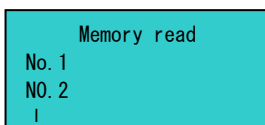
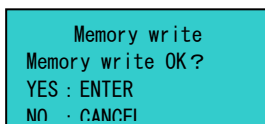

This key is exclusive to the VR601/801 model.

This key registers or calls the operating conditions previously set. Up to ten conditions can be registered for each operation menu.

To register the operating conditions,

set the name and determine the operating conditions on the operation setting screen and then press the MEMORY key. The screen goes into the MEMORY mode.

Press the ENTER key to start registration. After completing the registration, the screen returns to the standby screen.

To call the registered operating conditions,

press the MEMORY key for few seconds on the standby screen to go into the call screen. Select the name of operating condition with the Δ / ∇ keys and then press the ENTER key. The screen starts to call the memory with the display indicating that the condition is currently being called. The screen changes to the standby screen again. Start the operation with the START/STOP key.

7.Operation Function

Key Functions and Operations

MAINTENANCE key

```
Type Select
Release Mode
Fixed value Mode
↓
```

Operation mode selection

```
Fixed Value Mode
Data Type
Yamato No. 1
↓
```

Standby

```
Maintenance Mode
Roter Switching
Juck Switching
↓
```

Maintenance mode

```
Roter Switching
0. Auto
1. Manual
```

Rotation control switching function

This function selects the start/stop method of rotor on the main body at start/end of operation.

0: Auto 1: Manual

```
Juck Switching
0. Auto
1. Manual
```

Jack control switching function (for automatic operation of RE801 model only)

This function selects the start/stop method of up/down operation on the lifter of main body at start/completion of operation.

0: Auto 1: Manual

```
Bath Switching
0. Auto
1. Manual
```

Bath control operation switching function

This function stops the operation of BM500/510 and BO400/410 models or keeps it in the state of heat-retention, interlocked with the operation of main body.

Select "0" (Auto) to interlock it with the bath.

0: Auto 1: Manual

Note: Use the MAINTENANCE mode on the bath to select the state (operation stop/heat-retention/non-interlocking operation).

```
Pressure CAL
**hPa
AFTER **0hPa
BEFORE**0hPa
```

Vacuum pressure offset function

This function corrects the indicated value of vacuum pressure in increments of 1 Pa if it differs from the actual vacuum pressure. Input the correct pressure with the $\Delta \nabla$ key and then press the ENTER key.

```
Press Switching
0. P-3000S
1. P-8300
```

Pressure sensor switching function

The parameter should be changed when using the optional pressure sensor for the use of solvent (P-8300).

0: P-3000S(standard sensor) 1: P-8300 (optional sensor)

Select the type of sensor with the $\Delta \nabla$ key and then press the ENTER key.

```
Vapor Select
0. OFF
1. ON
```

Presence/absence of evaporating temperature sensor

This function specifies the presence or absence of evaporating temperature sensor. Set "0" (absent) when evaporating temperature sensor is not used. Usually "1" (present) is set here.

Select "0" or "1" with the $\Delta \nabla$ key and then press the ENTER key.

7.Operation Function

Key Functions and Operations

Cool Select

0. OFF
1. ON

Presence/absence of cooling temperature sensor

This function specifies the presence or absence of cooling temperature sensor.
Set "0" (absent) when cooling temperature sensor is not used. Usually "0" (absent) is set here.

Select "0" or "1" with the $\Delta\nabla$ key and then press the ENTER key.

Vapor DP

0. OFF
1. ON

Presence/absence of evaporating temperature sensor

This function specifies the presence or absence of decimal point in the display of evaporating temperature.

Set "0" (absent) when evaporating temperature sensor is not used. Usually "1" (present) is set here.

Select "0" or "1" with the $\Delta\nabla$ key and then press the ENTER key.

Key Sound

0. OFF
1. ON

Presence/absence of key buzzer sound

This function specifies the presence or absence of key buzzer sound.

0: No key buzzer sound 1: Key buzzer sound ("1" is set at factory shipment)

Select "0" or "1" with the $\Delta\nabla$ key and then press the ENTER key.

Time Up Sound

0. OFF
1. ON

Presence/absence of time up sound

This function mutes the buzzer sound at the end of timer operation or automatic operation.

0: No time up sound 1: Time up sound ("1" is set at factory shipment)

Select "0" or "1" with the $\Delta\nabla$ key and then press the ENTER key.

Pattern Lock

0. OFF
1. ON

Pattern lock function (for RE801 model only)

This function is exclusive to the RE801 model, which prevents deletion of principal operating conditions.

0: OFF ("0" is set at factory shipment) 1: ON

Select "0" or "1" with the $\Delta\nabla$ key and then press the ENTER key.

Key Lock

0. OFF
1. ON

Keylock function

Only the MAINTENANCE key is operable after the keylock is selected during the operation.

0: OFF ("0" is set at factory shipment) 1: ON

Select "0" or "1" with the $\Delta\nabla$ key and then press the ENTER key.

Language

0. JAPANESE
1. ENGLISH

Language choice function

This function selects the language used in the LCD display.

0: JAPANESE 1: ENGLISH

Select "0" or "1" with the $\Delta\nabla$ key and then press the ENTER key.

AUTO Cleaning

00m x s

AUTO Cleaning function

After the main unit stops, vacuum pump is stopped after the set up time (unit: second) for exclude a remained solvent.

Set up the range from "3"(sec) to "60"(min) with the $\Delta\nabla$ key.

"300"(sec) is set at factory shipment.

Err' s career

No. 01

Vapor Sensor err
*hour ago

Error log

This function displays up to 20 errors occurred in the past, including the error No., error content and time of occurrence.

Select the error No. with the $\Delta\nabla$ keys. The latest error is displayed first.

Press the ENTER key to return to the MAINTENANCE screen.

7.Operation Function

Key Functions and Operations

Addition Time
***hour

Accumulated time

This function displays the operating hours (accumulated current-carrying time to the controller).

Press the ENTER key to return to the MAINTENANCE screen.

Temp Point
x x s

Ultimate temperature point

This function detects the evaporating temperature during operation and specifies the timing (unit: second) of memorizing the evaporating temperature when the memory function is used.

The point on the evaporating temperature curve, few seconds after the evaporating temperature becomes stable, is specified as a memorization point.

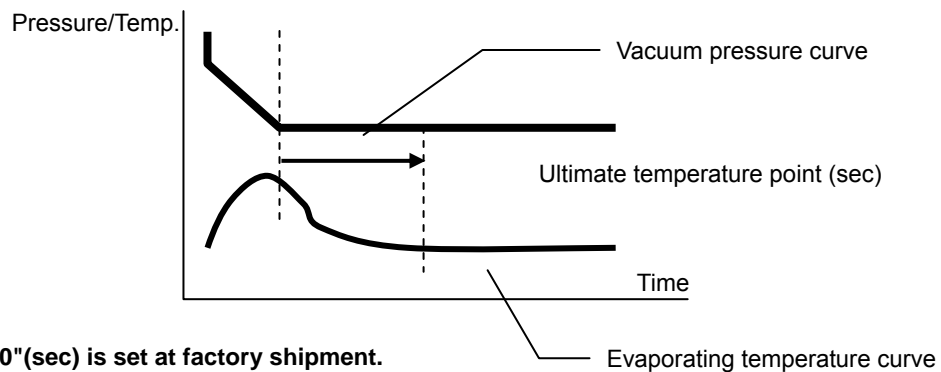

Slope Cycle
x x s

Slope cycle setting

This function sets up the time of period to decompression at Descending operation/Descending timer operation.

The decompression value of the every slope periodic is calculated from the set pressure and the FV time.

Start MV
x x %

Main valve output

The rate of main valve output ON (Open)/OFF (Close) to the slope cycle is set up.

If you set up Slope cycle is 10 sec and Start MV is 40.0%, the main valve open 4 sec and close 6 sec.

It is 100% at Free operation nevertheless any set up

Standby Screen/Operation Mode Selection Screen

Standby screen display

Select the MEMU key on the operation selection screen after power-on to go into the standby screen.
An error is displayed on the screen if occurred.

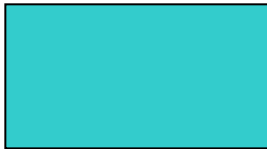

Power OFF state. The screen displays nothing.

↓ Power ON

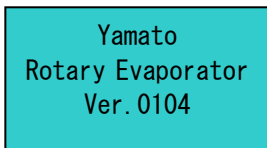

The initial screen is displayed and becomes extinct automatically after 4 seconds.

Turn on the power supply of the vacuum controller.

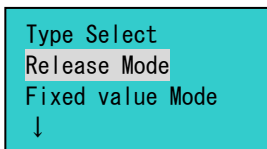

The operation mode selection screen is displayed.
Push the MENU key or CANCEL key.

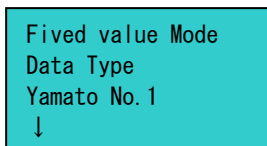

The standby screen of operation mode used previously is displayed.
The display of operation mode, name, pressure and temperature varies depending on the model or settings.

Use the DISPLAY key to advance the screen.

The START/STOP key can start/stop the operation.

Operation mode selection screen

Select each operation mode at the operation mode selection screen.

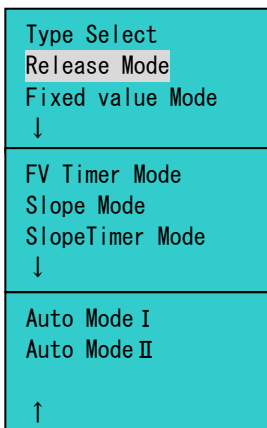

- ① Select the operation menu with the Δ / ∇ keys.

The LCD screen consists of four-line display in one page. The arrow (\downarrow) on the screen indicates that it has the next screen.

- ② Select the desired operation mode with the ENTER key.

Automatic operations I, II are exclusive functions to RE801 model. The RE601 models do not display these modes.

Operation Setting Screen

Press down the ENTER key on the operation selection screen to go into the operation setting screen. Operating conditions of respective operation menu can be set here.

Note: Free operation has no setting items. The screen changes to the standby screen.

Selection example	Description/operation
SlopeTimer Mode Data Type YAMATO No. 1 ↓	<ul style="list-style-type: none"> The selected operation mode is displayed. Press the ENTER key to go into the setting screen of data operation when fixed temperature, fixed temperature timer, descending, or descending timer operation is selected. Determine if data operation is performed or not with the ENTER key. When "1" (ON) is selected, the vacuum pressure during operation is automatically set by the automatic calculating system. Press the ENTER key on the registered name display screen to display the name setting screen. Register the name with the Δ∇ and ENTER key. Press the ENTER key for few seconds to return to the setting screen.
Ethanol MatterA **** MatterB ***** ↓	<ul style="list-style-type: none"> Press the ENTER key to select and determine the name of registered material. Select the material name registered with the Δ∇ keys. Press the ENTER key to determine the setting. These constants are used at either the fixed temperature, fixed temperature timer, descending, or descending timer operation. They are used to automatically calculate the optimum vacuum pressure to the evaporating temperature when performing the data operation using the automatic calculating system of solvent curve. At the data operation, the three Antoine constants A, B and C are required to be set. If the one of No. 1 to 10 is selected, constants should be input for each operation. As for the data of 53 solvents already registered, they have been already input and are not displayed on the screen. Select the constant and change/set the value with the Δ∇ keys.
MatterC ***** Temp *. *°C CalcPress**hPa ↓	<ul style="list-style-type: none"> Press the ENTER key and specify the desired evaporating temperature with the Δ∇ keys. Displayed only at the data operation on either the fixed temperature, fixed temperature timer, descending, or descending timer operation. It displays the vacuum pressure value automatically calculated by the automatic calculating system.
Press **hPa Hys Press **hPa Slope **hPa ↓	<ul style="list-style-type: none"> Specify the operating pressure with the Δ∇ keys when data operation is not selected. Fine adjust the operating pressure with these keys when data operation is selected. Set the ON/OFF width of the control solenoid valve (pressure hysteresis) in operating pressure with the Δ∇ keys. Set the pressure at the start of descending operation with the Δ∇ keys.
Slope Time *m FV Time *m Slope MV ↓	<ul style="list-style-type: none"> Set the duration from the start of descending to the completion with the Δ∇ keys. Set the duration of fixed temperature operation at timer operation with the Δ∇ keys. The descending speed of pressure can be controlled in increments of % at the automatic operation I, II on the RE801 model. Control the percentage with the Δ∇ keys.
End Temp End Time ↓	<ul style="list-style-type: none"> In the automatic operations I, II on the RE801 model, the evaporating temperature determines the operation completion at automatic operation. The temperature can be fine adjusted here. It is set to 10°C at factory shipment. In the automatic operation I on the RE801 model, the evaporating temperature automatically determines the operation completion. The operating time, however, can be extended by inputting the drying time. The device continues operation by the input time and then stops.
Vapor Temp Cool Temp ↑	<ul style="list-style-type: none"> The evaporating temperature (the value on the evaporating temperature sensor) is displayed. The cooling water temperature (the value on the cooling temperature sensor) connected to the outlet of condenser is displayed.

Name Registration

On the VR model vacuum controller, a specific name can be registered to the operating condition created. This function is useful when using the memory function included in the RE601 and RE801 models.

Available characters for name registration

Use the following characters to register the name.

No.	Character	No.	Character	No.	Character	No.	Character
1	(Space)	41	d	81	ツ	121	°
2	0	42	e	82	テ	122	。
3	1	43	f	83	ト	123	、
4	2	44	g	84	ナ	124	!
5	3	45	h	85	ニ	125	”
6	4	46	i	86	ヌ	126	#
7	5	47	j	87	ネ	127	\$
8	6	48	k	88	ノ	128	%
9	7	49	l	89	ハ	129	&
10	8	50	m	90	ヒ	130	'
11	9	51	n	91	フ	131	(
12	A	52	o	92	ヘ	132)
13	B	53	p	93	ホ	133	*
14	C	54	q	94	マ	134	+
15	D	55	r	95	ミ	135	,
16	E	56	s	96	ム	136	-
17	F	57	t	97	メ	137	.
18	G	58	u	98	モ	138	/
19	H	59	v	99	ヤ	139	:
20	I	60	w	100	ユ	140	;
21	J	61	x	101	ヨ	141	<
22	K	62	y	102	ラ	142	>
23	L	63	z	103	リ	143	=
24	M	64	ア	104	ル	144	?
25	N	65	イ	105	レ	145	@
26	O	66	ウ	106	ロ	146	[
27	P	67	エ	107	ワ	147]
28	Q	68	オ	108	ヲ	148	¥
29	R	69	カ	109	ン	149	^
30	S	70	キ	110	ア	150	_
31	T	71	ク	111	イ	151	˘
32	U	72	ケ	112	ウ	152	{
33	V	73	コ	113	エ	153	}
34	W	74	サ	114	オ	154	
35	X	75	シ	115	ヤ	155	~
36	Y	76	ス	116	ユ	156	「
37	Z	77	セ	117	ヨ	157	」
38	a	78	ソ	118	ツ	158	•
39	b	79	タ	119	ー		
40	c	80	チ	120	°		

Name Registration

Name Registrations Procedures

Start name registration on the setting screen of operation mode used. Up to 16 one-byte characters (refer to the previous page) can be input to register the name.

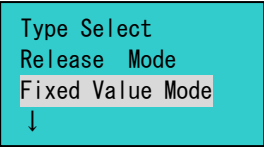
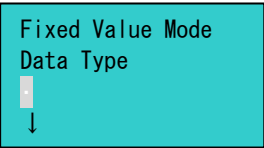
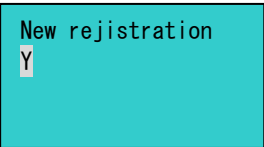
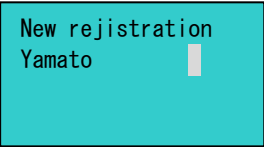
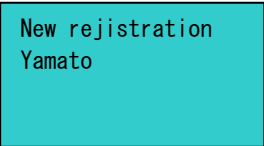
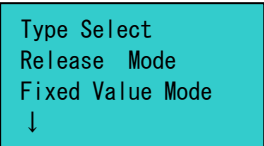
Screen	Procedures
 <p>↓ ENTER key</p>  <p>↓ Δ▽ key</p>  <p>↓ ENTER key</p>  <p>↓ Δ▽ key</p>  <p>↓ MENU key</p> 	<p>① Select the desired operation mode on the operation selection screen.</p> <p>② Press the ENTER key to go into the setting screen.</p> <p>③ Select the name entry field with the Δ▽ keys.</p> <p>④ Press the ENTER key to go into the name registration screen.</p> <p>⑤ Specify the first character with the Δ▽ keys.</p> <p>⑥ Press the ENTER key to determine the first character. The screen shifts to the next character entry.</p> <p>⑦ Repeat the steps ③ and ④ to create the name.</p> <p>⑧ Up to 16 one-byte characters (refer to the previous page) can be input. Press the ENTER key to skip the entry field where a character is not input. Press the ENTER key for few second when determining the name in the middle of input. The screen returns to the setting screen.</p> <p>⑨ The screen returns to the screen for the first character if the ENTER key is pressed on the entry field for 16th character.</p> <p>⑩ Press the ENTER key for few seconds to return to the setting screen.</p>

Data Operation

Automatic calculating system of vacuum pressure at data operation

Data operation by automatic calculating system on the RE601/801 model is described. This function is exclusive to the RE601/801 model.

This function is applicable to operation modes of fixed temperature, fixed temperature time, descending and descending timer on the RE601/801 model. The calculating function of the optimum vacuum pressure necessary for the data operation is previously registered for 53 kinds of solvent. The distilling operation optimum for the solvent to be used, therefore, can be performed by selecting the solvent name used and by setting the evaporating temperature (bath temperature).

The preset vacuum pressure is automatically calculated using the Antoine's three constants (constants A, B and C), based on the evaporating temperature curve for respective solvents. These constants related to the 53 solvents listed below are previously registered respectively and the optimum vacuum pressure for operation can be automatically set by only selecting the name of solvent used. The distilling temperature (bath temperature) of sample (solvent), however, varies depending on the distilling conditions and must be set with respect to each operation.

Registered solvents

No.	Indication	No.	Indication	No.	Indication
1	No.01	22	Diisoproryl ether	43	Propyl acetate
2	No.02	23	Hexane	44	Toluene
3	No.03	24	Hydrogen peroxide	45	Pyridine
4	No.04	25	Ethyl iodide	46	Isobutanol
5	No.05	26	Tetrachloromethane	47	1-Butanol
6	No.06	27	Ethyl acetate	48	Acetic acid
7	No.07	28	Acrylonitrile	49	Butyl iodide
8	No.08	29	Ethanol	50	Chlorobenzene
9	No.09	30	Benzene	51	p-Xylene
10	No.10	31	Cycrohexane	52	N [^] Pentanol
11	Diethyl ether	32	Acetonitrile	53	Acetic anhydridel
12	Pentane	33	2-Propanol	54	m-Xylene
13	Bromo ethane	34	1,2-Dichloroethane	55	o-Xylene
14	Dichloromethane	35	Nitric acid	56	Styrene
15	Cycropentane	36	Trichloroethylene	57	N,N-dimethylformamide
16	Acetone	37	1-Propanol	58	1-Hexanol
17	Methyl acetate	38	Heptane	59	Phenol
18	1,1-Dichloromethane	39	2-Butanol	60	Aniline
19	Chloroform	40	Water	61	Methyl benzoate
20	Methanol	41	Formic acid	62	Ethyl benzoate
21	Tetrahydrofuranl	42	1,4-Dioxane	63	Benzoic acid

The solvent Nos. 1 thru No.10 are used to register the user-specified solvents. The Antoine constants A, B and C for these solvents, therefore, must be input by the user.

Data Operation

The material table registered solvents is listed below

No.	solvent	general formula	M (g/mol)	b.p. (at 1013hPa)	steam pressure at 20°C (hPa)	steam pressure at 40°C (hPa)
11	Diethyl ether	C ₆ H ₁₀ O	74.1	35	587	SATP
12	Pentane	C ₅ H ₁₂	72.2	36	565	SATP
13	Bromo ethane	C ₂ H ₅ Br	109.0	38	515	SATP
14	Dichloromethane	CH ₂ Cl ₂	84.9	40	474	SATP
15	Cyclopentane	C ₅ H ₁₀	70.1	49	346	740
16	Acetone	C ₃ H ₆ O	58.1	57	246	562
17	Methyl acetate	C ₃ H ₆ O ₂	74.1	57	230	541
18	1,1-Dichloroethane	C ₂ H ₄ Cl ₂	99.0	57	245	551
19	Chloroform	CHCl ₃	119.4	62	209	473
20	Methanol	CH ₄ O	32.0	65	130	354
21	Tetrahydrofuran	C ₄ H ₈ O	72.1	66	173	402
22	Diisopropyl ether	C ₆ H ₁₄ O	102.2	69	155	367
23	Hexane	C ₆ H ₁₄	86.2	69	162	373
24	Hydrgen peroxide	H ₂ O ₂	34.0	141	2	7
25	Ethyl iodide	C ₂ H ₅ I	156.0	72	146	335
26	Tetrachloromethane	CCl ₄	153.8	77	121	284
27	Ethyl acetate	C ₄ H ₈ O ₂	88.1	77	101	225
28	Acrylonitrile	C ₃ H ₃ N	53.1	77	90	225
29	Ethanol	C ₂ H ₆ O	46.1	78	59	179
30	Benzene	C ₆ H ₆	78.1	80	100	244
31	Cyclohexane	C ₆ H ₁₂	78.1	81	103	246
32	Acetonitrile	C ₂ H ₃ N	41.1	82	90	225
33	2-Propanol	C ₃ H ₈ O	60.1	82	44	142
34	1,2-Dichloroethane	C ₂ H ₄ Cl ₂	99.0	84	83	206
35	Nitric acid	HNO ₃	63.0	83	64	178
36	Trichloroethylene	C ₂ HCl ₃	131.4	87	78	192
37	1-Propanol	C ₃ H ₈ O	60.1	97	19	70
38	Heptane	C ₇ H ₁₆	100.2	98	47	123
39	2-Butanol	C ₄ H ₁₀ O	74.1	100	17	63
40	Water	H ₂ O	18.0	100	23	74
41	Formic acid	CH ₂ O ₂	46.0	101	45	111
42	1,4-Dioxane	C ₆ H ₈ O ₂	88.1	101	36	99
43	Propyl acetate	C ₅ H ₁₀ O ₂	102.1	97	33	94
44	Toluene	C ₇ H ₈	92.1	111	29	79
45	Pyridine	C ₅ H ₅ N	79.1	115	21	60
46	Isobutanol	C ₄ H ₁₀ O	74.1	108	10	39
47	1-Butanol	C ₄ H ₁₀ O	74.1	117	6	24
48	Acetic acid	C ₂ H ₄ O ₂	60.1	118	15	46
49	Butyl iodide	C ₄ H ₉ I	184.0	131	14	40
50	Chlorobenzene	C ₆ H ₅ Cl	112.6	131	12	35
51	p-Xylene	C ₈ H ₁₀	106.2	138	9	26
52	n-Pentanol	C ₅ H ₁₂ O	88.2	138	2	10
53	Acetic anhydride	C ₄ H ₆ O ₃	102.1	140	5	18
54	m-Xylene	C ₈ H ₁₀	106.2	139	8	25
55	o-Xylene	C ₈ H ₁₀	106.2	144	7	20
56	Stylene	C ₈ H ₈	104.2	145	6	19
57	N,N-dimethylformamide	C ₃ H ₇ NO	73.0	153	4	12
58	1-Hexanol	C ₆ H ₁₄ O	104.4	157	1	3
59	Phenol	C ₆ H ₆ O	94.1	182	0	2
60	Aniline	C ₆ H ₇ N	93.1	184	1	2
61	Methyl benzoate	C ₈ H ₈ O ₂	136.2	199	0	1
62	Ethyl benzoate	C ₈ H ₁₀ O ₂	150.2	212	0	1
63	Benzoic acid	C ₇ H ₆ O ₂	122.1	249	0	0

Free Operation

This operation mode does not require the vacuum controller. In this mode, the control solenoid valve on the vacuum controller always remains open.

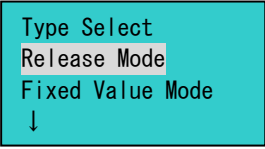
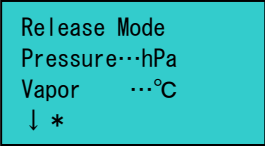
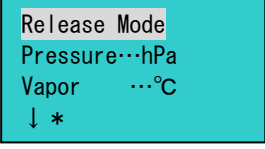
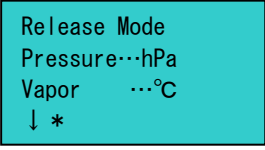
Screen	Procedures
 <p>Type Select Release Mode Fixed Value Mode ↓</p>	<p>① Select the free operation on the setting screen with the Δ/∇ keys, and then press the ENTER key.</p>
 <p>Release Mode Pressure...hPa Vapor ...°C ↓ *</p>	<p>② The screen changes to the free operation standby screen. ❖ When the optional cooling temperature sensor is connected, the cooling temperature (°C) is displayed.</p>
 <p>Release Mode Pressure...hPa Vapor ...°C ↓ *</p>	<p>③ Press the START/STOP key to start the operation. The operation name currently operated blinks. ❖ When the optional cooling temperature sensor is connected, the cooling temperature (°C) is displayed.</p>
 <p>Release Mode Pressure...hPa Vapor ...°C ↓ *</p>	<p>④ Press the START/STOP key to stop the operation. The screen changes to the free operation standby screen. ❖ When the optional cooling temperature sensor is connected, the cooling temperature (°C) is displayed.</p>

Fixed Temperature Operation

In this operation mode, the device performs continuous operation with the preset vacuum pressure.

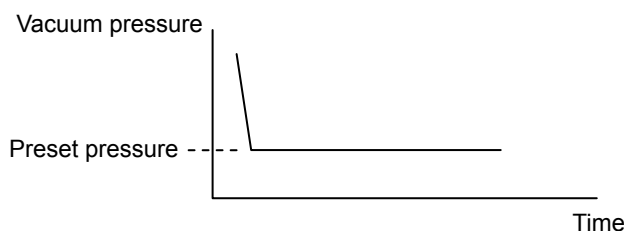

Screen	Procedures
<div style="border: 1px solid black; padding: 5px; background-color: #e0f2f1;"> Type Select Release Mode Fixed Value Mode ↓ ↓ ENTER key </div>	<ol style="list-style-type: none"> ① Select the fixed temperature operation on the setting screen with the $\Delta\nabla$ keys, and then press the ENTER key. (The content of display varies depending on the model RE601/801). ② The screen changes to the setting screen. (The content of display varies depending on the model RE601/801). Press the $\Delta\nabla$ keys or DISPLAY key to advance the screen. ③ Select the data operation and then select "ON" or "OFF".

When selecting "ON"...

<div style="border: 1px solid black; padding: 5px; background-color: #e0f2f1;"> Fixed Value Mode Data Type Yamato No. 1 ↓ </div>	<ol style="list-style-type: none"> ① Select the data operation → ENTER → select 1.ON → ENTER ② To create the operation name, → ENTER → (repeat "$\Delta\nabla$ → ENTER") → press ENTER longer
<div style="border: 1px solid black; padding: 5px; background-color: #e0f2f1;"> Eethanol Temp **°C CalcPress **hpa ↓ </div>	<ol style="list-style-type: none"> ③ Performs solvent selection → ENTER → select the solvent to be used with $\Delta\nabla$ → ENTER ④ Determine the preset temperature → ENTER → change the temperature with $\Delta\nabla$ → ENTER Calculated pressure is displayed only.
<div style="border: 1px solid black; padding: 5px; background-color: #e0f2f1;"> Press ****hPa Hys. Press **hPa Vapor **°C ↓ </div>	<ol style="list-style-type: none"> ⑤ Used to fine adjust the result of calculated pressure at data operation. ENTER → change the pressure with $\Delta\nabla$ → ENTER ⑥ Used to fine adjust the result of calculated pressure at data operation. ENTER → change the pressure with $\Delta\nabla$ → ENTER The measured evaporating temperature is displayed.
<div style="border: 1px solid black; padding: 5px; background-color: #e0f2f1;"> CoolTemp **°C ↑ </div>	<p>Displayed only when the RE601/801 optional cooling temperature sensor is connected.</p>

Fixed Temperature Operation

When selecting "OFF"...

Fixed Value Mode
Data Type
Yamato No. 1
↓

- ① Select the data operation → ENTER → select 1.OFF → ENTER
- ② To create the operation name, → ENTER → (repeat "Δ∇ → ENTER") → press ENTER longer

Press ****hPa
Hys.Press **hPa
Vapor ***°C
↓

- ③ Set the operating vacuum pressure.
ENTER → change the pressure with Δ∇ → ENTER
- ④ Determine the ON/OFF width of solenoid valve at fixed temperature operation.
ENTER → change the pressure with Δ∇ → ENTER
The measured evaporating temperature is displayed.

CoolTemp **°C
↑

Displayed only when the RE601/801 optional cooling temperature sensor is connected.

Operation start/stop

Fixed Value Mode
Data Type
Yamato No. 1
↓

↓ START/STOP key

Fixed Value Mode
Yamato No. 1
Press ****hPa
↓

- ① Press the START/STOP key. The device goes into the selected operation mode and the operation name to be performed blinks. The device then starts operation.
Press the Δ∇ keys or DISPLAY key to advance the screen.
Current pressure and current evaporation temperature are displayed.

↓ START/STOP key

Fixed Value Mode
Data Type
Yamato No. 1
↓

- ② Press the START/STOP key to stop the operation.
Press the MENU key on the standby screen to change the operation menu.

Screen switching during the operation

Parameter indication can be switched to the Graphic indication by pushing a DISPLAY key for several seconds during the operation. It is indicated on the screen the process of present operation on and off, pressure and evaporating temperature are indicated at present.

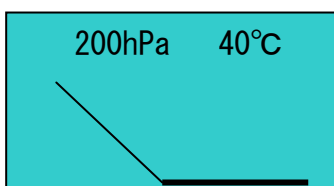

Fixed Temperature Timer Operation

This operation mode performs continuous operation with the preset vacuum pressure and automatically stops at the preset time.

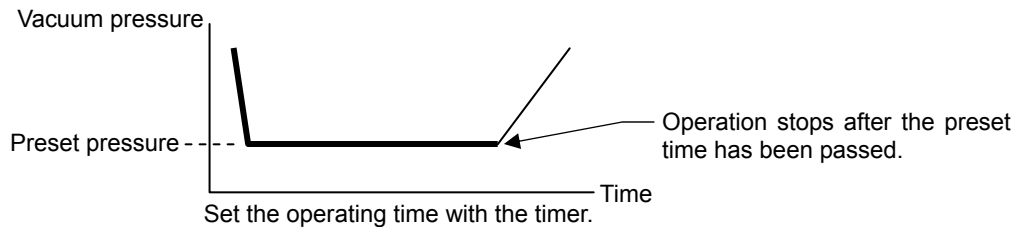

Screen	Procedures
<div style="border: 1px solid black; padding: 5px; background-color: #e0f2f1;"> FV Timer Mode Slope Mode Slope Timer Mode ↓ ↓ ENTER key </div>	<ol style="list-style-type: none"> ① Select the fixed temperature timer operation on the setting screen with the $\Delta\nabla$ keys, and then press the ENTER key. (The content of display varies depending on the model RE601/801). ② The screen changes to the setting screen. (The content of display varies depending on the model RE601/801). Press the $\Delta\nabla$ keys or DISPLAY key to advance the screen. ③ Select the data operation and then select "ON" or "OFF".

When selecting "ON"...

<div style="border: 1px solid black; padding: 5px; background-color: #e0f2f1;"> FV Timer Mode Data Type Yamato No.1 ↓ </div>	<ol style="list-style-type: none"> ① Select the data operation → ENTER → select 1.ON → ENTER ② To create the operation name, → ENTER → (repeat "$\Delta\nabla$ → ENTER") → press ENTER longer
<div style="border: 1px solid black; padding: 5px; background-color: #e0f2f1;"> Ethanol Temp **°C CalcPress **hpa ↓ </div>	<ol style="list-style-type: none"> ③ Performs solvent selection → ENTER → select the solvent to be used with $\Delta\nabla$ → ENTER ④ Determine the preset temperature → ENTER → change the temperature with $\Delta\nabla$ → ENTER Calculated pressure is displayed only.
<div style="border: 1px solid black; padding: 5px; background-color: #e0f2f1;"> Press **hPa Hys Press **hPa FV Time **m ↓ </div>	<ol style="list-style-type: none"> ⑤ Used to fine adjust the result of calculated pressure at data operation. ENTER → change the pressure with $\Delta\nabla$ → ENTER ⑥ Used to fine adjust the result of calculated pressure at data operation. ENTER → change the pressure with $\Delta\nabla$ → ENTER ⑦ Set the operating time. ENTER → Set the operating time with $\Delta\nabla$ → ENTER
<div style="border: 1px solid black; padding: 5px; background-color: #e0f2f1;"> Vapor ***°C Cool Temp **°C ↑ </div>	<p>The measured evaporating temperature is displayed.</p> <p>Displayed only when the RE601/801 optional cooling temperature sensor is connected.</p>

Fixed Temperature Timer Operation

When selecting "OFF"...

```
FV Timer Mode
Data Type
Yamato No.1
↓
```

- ① Select the data operation → ENTER → select 1.OFF → ENTER
- ② To create the operation name, → ENTER → (repeat "Δ∇ → ENTER") → press ENTER longer

```
Press **hPa
Hys Press **hPa
FV Time **m
↓
```

- ③ Set the operating vacuum pressure.
ENTER → change the pressure with Δ∇ → ENTER
- ④ Determine the ON/OFF width of solenoid valve at fixed temperature operation.
ENTER → change the pressure with Δ∇ → ENTER
- ⑤ Input the time for fixed temperature operation. (The remaining time is displayed during operation.)

```
Vapor ***°C
Cool Temp **°C ←
↑
```

The measured evaporating temperature is displayed.

Displayed only when the RE601/801 optional cooling temperature sensor is connected.

Operation start/stop

```
FV Timer Mode
Yamato No.1
Press **hPa
↓
```

↓ START/STOP key

```
FV Timer Mode
Yamato No.1
Press **hPa
↓
```

↓ START/STOP key

- ① Press the START/STOP key. The device goes into the selected operation mode and the operation name to be performed blinks. The device then starts operation.
Press the Δ∇ keys or DISPLAY key to advance the screen.
Current pressure, current evaporation temperature and remaining time are displayed.

```
FV Timer Mode
Yamato No.1
Press **hPa
↓
```

- ② Press the START/STOP key to stop the operation.
Press the MENU key on the standby screen to change the operation menu.

Screen switching during the operation

Parameter indication can be switched to the Graphic indication by pushing a DISPLAY key for several seconds during the operation. It is indicated on the screen the process of present operation on and off, pressure and evaporating temperature are indicated at present.

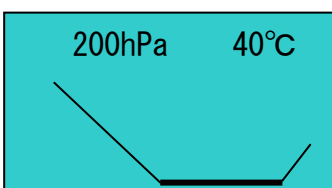

Descending Operation Procedures

In this mode, the vacuum pressure descends gradually to the preset fixed vacuum pressure to prevent the bumping.

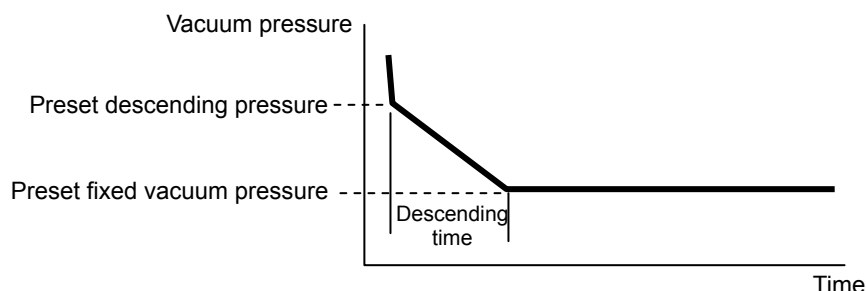

Screen	Procedures
<div style="border: 1px solid black; padding: 5px; background-color: #e0f2f1;"> FV Timer Mode Slope Mode Slope Timer Mode ↓ ↓ ENTER key </div>	<ol style="list-style-type: none"> ① Select the descending operation on the setting screen with the $\Delta\nabla$ keys, and then press the ENTER key. ② The screen changes to the setting screen. (The content of display varies depending on the model RE601/801). Press the $\Delta\nabla$ keys or DISPLAY key to advance the screen. ③ Select the data operation and then select "ON" or "OFF".

When selecting "ON"...

<div style="border: 1px solid black; padding: 5px; background-color: #e0f2f1;"> Slope Mode Data Type Yamato No. 1 ↓ </div>	<ol style="list-style-type: none"> ① Select the data operation → ENTER → select 1.ON → ENTER ② To create the operation name, → ENTER → (repeat "$\Delta\nabla$ → ENTER") → press ENTER longer
<div style="border: 1px solid black; padding: 5px; background-color: #e0f2f1;"> Eethanol MatterA ***** MatterB ***** ↓ </div>	<ol style="list-style-type: none"> ③ Performs solvent selection → ENTER → select the solvent to be used with $\Delta\nabla$ → ENTER When one of the solvents No. 1 to 10 is selected, three constants should be input. As for the data of 53 solvents already registered, these constants have been already input and are not displayed on the screen.
<div style="border: 1px solid black; padding: 5px; background-color: #e0f2f1;"> MatterC ***** Temp ***°C CaicPress***hPa ↓ </div>	<ol style="list-style-type: none"> ④ Determine the preset temperature → ENTER → change the temperature with $\Delta\nabla$ → ENTER Calculated pressure is displayed only.
<div style="border: 1px solid black; padding: 5px; background-color: #e0f2f1;"> Press ***hPa Hys Press **hPa Slope ***hPa ↓ </div>	<ol style="list-style-type: none"> ⑤ Used to fine adjust the result of calculated pressure at data operation. ENTER → change the pressure with $\Delta\nabla$ → ENTER ⑥ Used to fine adjust the result of calculated pressure at data operation. ENTER → change the pressure with $\Delta\nabla$ → ENTER
<div style="border: 1px solid black; padding: 5px; background-color: #e0f2f1;"> Slope Time **m Vapor ***°C Cool TemP **°C ↑ </div>	<ol style="list-style-type: none"> ⑦ Set the vacuum pressure at the start of descending. ⑧ Set the descending time. ENTER → Set the descending time with $\Delta\nabla$ → ENTER The measured evaporating temperature is displayed. Displayed only when the RE601/801 optional cooling temperature sensor is connected.

Descending Operation Procedures

When selecting "OFF"...

```
Slope Mode
Data Type
Yamato No.1
↓
```

- ① Select the data operation → ENTER → select 1.OFF → ENTER
- ② To create the operation name, → ENTER → (repeat "Δ∇ → ENTER") → press ENTER longer

```
Press ****hPa
Hys Press***hPa
Slope Press**hPa
↓
```

- ③ Set the operating vacuum pressure.
ENTER → change the pressure with Δ∇ → ENTER
- ④ Determine the ON/OFF width of solenoid valve at fixed temperature operation.
ENTER → change the pressure with Δ∇ → ENTER

```
Slope Time **m
Vapor **°C
Cool Temp**°C ←
↑
```

- ⑤ Set the vacuum pressure at the start of descending.
- ⑥ Input the descending time.
The measured evaporating temperature is displayed.
Displayed only when the RE601/801 optional cooling temperature sensor is connected.

Operation start/stop

```
Slope Mode
Yamato No.1
Press ****hPa
↓
```

↓ START/STOP key

```
Slope Mode
Yamato No.1
Press ****hPa
↓
```

↓ START/STOP key

- ① Press the START/STOP key. The device goes into the selected operation mode and the operation name to be performed blinks. The device then starts operation.
Press the Δ∇ keys or DISPLAY key to advance the screen.
Current pressure, current evaporation temperature and remaining time are displayed.
- ② Press the START/STOP key to stop the operation.
Press the MENU key on the standby screen to change the operation menu.

```
Slope Mode
Yamato No.1
Press ****hPa
↓
```

Screen switching during the operation

Parameter indication can be switched to the Graphic indication by pushing a DISPLAY key for several seconds during the operation. It is indicated on the screen the process of present operation on and off, pressure and evaporating temperature are indicated at present.

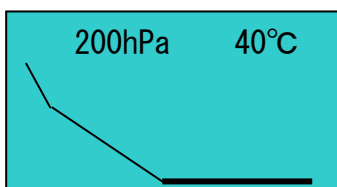

* The mixture solvent can operation.

Descending Timer Operation Procedures

In this mode, the timer function is added to the descending operation to automatically stop the operation at the preset time.

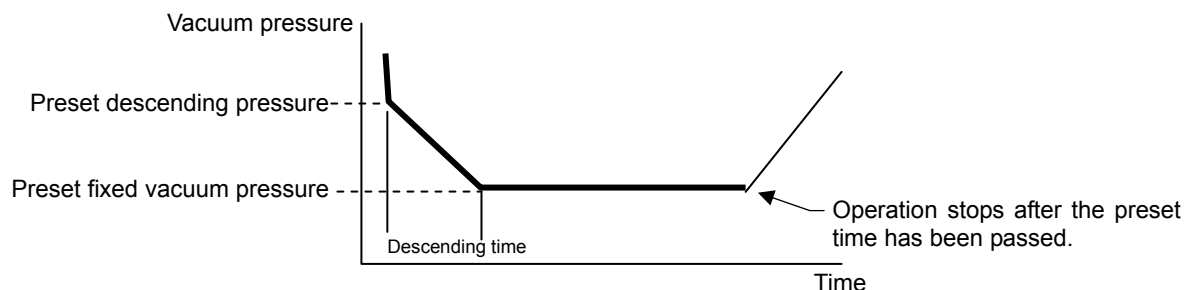

Screen	Procedures
<div style="border: 1px solid black; padding: 5px; background-color: #e0f2f1;"> FV Timer Mode Slope Mode Slope Timer Mode ↓ ↓ ENTER key </div>	<ol style="list-style-type: none"> ① Select the descending operation on the setting screen with the $\Delta\nabla$ keys, and then press the ENTER key. ② The screen changes to the setting screen. (The content of display varies depending on the model RE601/801). Press the $\Delta\nabla$ keys or DISPLAY key to advance the screen. ③ Select the data operation and then select "ON" or "OFF".

When selecting "ON"...

<div style="border: 1px solid black; padding: 5px; background-color: #e0f2f1;"> Slope Timer Mode Data Type Yamato No. 1 ↓ </div>	<ol style="list-style-type: none"> ① Select the data operation → ENTER → select 1.ON → ENTER ② To create the operation name, → ENTER → (repeat "$\Delta\nabla$ → ENTER") → press ENTER longer
<div style="border: 1px solid black; padding: 5px; background-color: #e0f2f1;"> Eethanol MatterA ***** MatterB ***** ↓ </div>	<ol style="list-style-type: none"> ③ Performs solvent selection → ENTER → select the solvent to be used with $\Delta\nabla$ → ENTER When one of the solvents No. 1 to 10 is selected, three constants should be input. As for the data of 53 solvents already registered, these constants have been already input and are not displayed on the screen.
<div style="border: 1px solid black; padding: 5px; background-color: #e0f2f1;"> MatterC ***** Temp ***°C CalcPress***hPa ↓ </div>	<ol style="list-style-type: none"> ④ Determine the preset temperature → ENTER → change the temperature with $\Delta\nabla$ → ENTER Calculated pressure is displayed only.
<div style="border: 1px solid black; padding: 5px; background-color: #e0f2f1;"> Press ***hPa Hys Press **hPa Slope ***hPa ↓ </div>	<ol style="list-style-type: none"> ⑤ Used to fine adjust the result of calculated pressure at data operation. ENTER → change the pressure with $\Delta\nabla$ → ENTER ⑥ Used to fine adjust the result of calculated pressure at data operation. ENTER → change the pressure with $\Delta\nabla$ → ENTER
<div style="border: 1px solid black; padding: 5px; background-color: #e0f2f1;"> Slope Time**°C FV Time **m Vapor ***°C ↓ </div>	<ol style="list-style-type: none"> ⑦ Set the vacuum pressure at the start of descending. ⑧ Set the descending time. ENTER → Set the descending time with $\Delta\nabla$ → ENTER ⑨ Set the fixed temperature operating time. ENTER → Set the fixed temperature operating time with $\Delta\nabla$ → ENTER The measured evaporating temperature is displayed.
<div style="border: 1px solid black; padding: 5px; background-color: #e0f2f1;"> Cool Temp **°C ↑ </div>	<p>Displayed only when the RE601/801 optional cooling temperature sensor is connected.</p>

Descending Timer Operation Procedures

When selecting "OFF"...

```
Slope Timer Mode
Data Type
Yamato No.1
↓
```

- ① Select the data operation → ENTER → select 1.OFF → ENTER
- ② To create the operation name, → ENTER → (repeat "Δ▽ → ENTER") → press ENTER longer

```
Press ***hPa
Hys Press **hPa
Slope ***hPa
↓
```

- ③ Set the operating vacuum pressure.
ENTER → change the pressure with Δ▽ → ENTER
- ④ Determine the ON/OFF width of solenoid valve at fixed temperature operation.
ENTER → change the pressure with Δ▽ → ENTER

```
Slope Time**°C
FV Time **m
Vapor ***°C
↓
```

- ⑤ Set the vacuum pressure at the start of descending.
- ⑥ Input the descending time.
- ⑦ Set the fixed temperature operating time.
The measured evaporating temperature is displayed.

```
Cool Temp **°C
↑
```

Displayed only when the RE601/801 optional cooling temperature sensor is connected.

Operation start/stop

```
Slope Timer Mode
Data Type
Yamato No.1
↓
```

↓ START/STOP key

```
Slope Timer Mode
Yamato No.1
Press ***hPa
↓
```

↓ START/STOP key

- ① Press the START/STOP key. The device goes into the selected operation mode and the operation name to be performed blinks. The device then starts operation.
Press the Δ▽ keys or DISPLAY key to advance the screen.
Current pressure, current evaporation temperature and remaining time are displayed.

```
Slope Timer Mode
Yamato No.1
Press ***hPa
↓
```

- ② Press the START/STOP key to stop the operation.
Press the MENU key on the standby screen to change the operation menu.

Screen switching during the operation

Parameter indication can be switched to the Graphic indication by pushing a DISPLAY key for several seconds during the operation. It is indicated on the screen the process of present operation on and off, pressure and evaporating temperature are indicated at present.

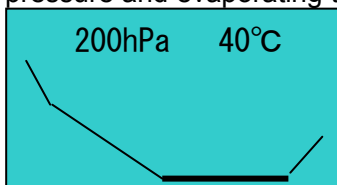

* The mixture solvent can operation.

Automatic Operation I Procedures

The automatic operation I and II have the function that detects the evaporating temperature and automatically set the optimum vacuum pressure for the distillation of sample (solvent) used.

- The automatic operation I is applicable to distill and dry the sample of single solvent.
- The automatic operation II is applicable to distill the sample of single solvent.

The automatic operation I is the exclusive function to the RE801 model.

The automatic operation I has the function that automatically starts the operation, dries the sample, and then stops the operation by setting the evaporating temperature.

The automatic operation I is a full automatic operation, consisting of the descending operation, fixed temperature operation, and distillation of sample using a single solvent. The operation end time can be extended by setting the timer.

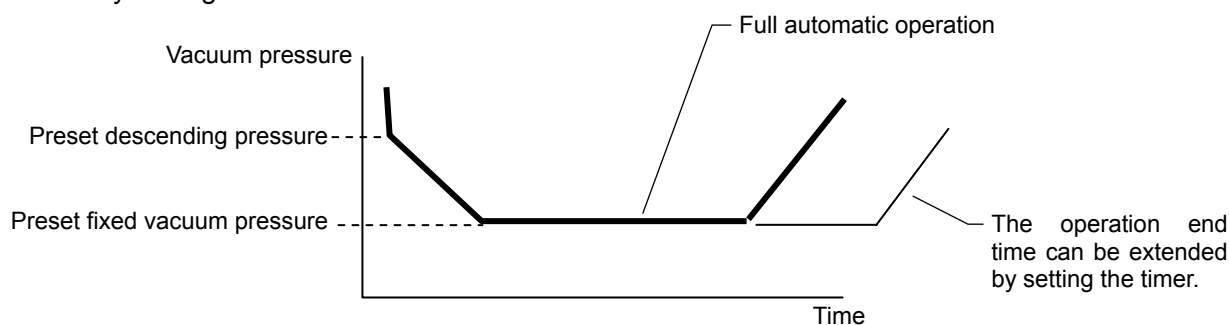

Screen	Procedures
<div style="background-color: #00b09b; color: white; padding: 5px;"> Auto Mode I Auto Mode II ↑ </div> <p>↓ ENTER key</p> <p>↓ START/STOP key</p>	<ol style="list-style-type: none"> ① Select the automatic operation I on the setting screen with the $\Delta \nabla$ keys, and then press the ENTER key. ② The screen changes to the setting screen. Press the $\Delta \nabla$ keys or DISPLAY key to advance the screen. ③ After the bath temperature has been stable, press the START/STOP key to start the operation. * Refer to the Instruction Manual of BM500/510 · BO400/410 "P.25" for the bath interlock function. The device automatically detects the evaporating temperature and automatically stops the operation.

Control the operating conditions.

Use the following procedures in order to change the operating conditions after performing one automatic operation.

Auto Mode I
 Yamato No.1
 Temp ***°C
 ↓

Perform on the setting screen.

① To create the operation name, → ENTER → (repeat " $\Delta \nabla$ → ENTER") → press ENTER longer

② Set the evaporating temperature.

Hys Press **hPa
 Slope Mv **%
 End Temp **°C
 ↓

③ Used to fine adjust the pressure ON/OFF width on the control solenoid valve at fixed temperature operation.
ENTER → change the pressure with $\Delta \nabla$ → ENTER

④ The descending curve on the descending operation can be fine adjusted by increments of %.

⑤ Used to fine adjust the detecting range (temperature) of evaporating temperature at operation end.

Automatic Operation I Procedures

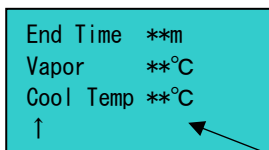

- ⑥ Input the end time to use the timer function. The operating time is extended by the duration of input after the evaporating temperature reaches the operation end temperature.
The measured evaporating temperature is displayed.
The cooling temperature is displayed when the optional cooling temperature sensor is connected.

Screen switching during the operation

Parameter indication can be switched to the Graphic indication by pushing a DISPLAY key for several seconds during the operation. It is indicated on the screen the process of present operation on and off, pressure and evaporating temperature are indicated at present.

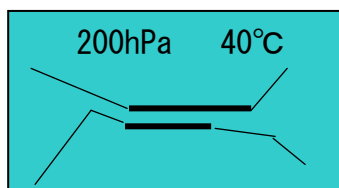

You must set up the both temperature, evaporating temperature and the circulating water temperature suitably to distill it from the viewpoint of efficiency. It's necessary to remove a thermal energy supplied by bath, sets up setup temperature lower than bath temperature about 20°C. And sets up cooling water temperature lower than setup temperature about 20°C to improve a recovery, too.

Example "Cooling water circulation unit use"

Bath temperature : 40°C Evaporating temperature : 20°C cooling water temperature : 0°C

Example "water service use"

Bath temperature : 60°C Evaporating temperature : 40°C cooling water temperature : 20°C

As for the "End Temperature" value, 2.0°C is recommended. However do the fine tuning of temperature the solvent is leaved when Automatic Operation is finished and Automatic Operation doesn't finish when after evaporation is completed.

The value of "End Temperature " is set up high when operation is finished with a solvent left.
The value of "End Temperature " is set up low when operation isn't finished after evaporation is completed.

* 0.5°C is a standard when you change "End Temperature".

Automatic Operation II Procedures

The automatic operation II is the exclusive function to the RE801 model.

The automatic operation II has the function that automatically starts or stops the operation by setting the evaporation temperature.

The automatic operation II is a full automatic operation, consisting of the descending operation, fixed temperature operation and drying of sample using a single solvent.

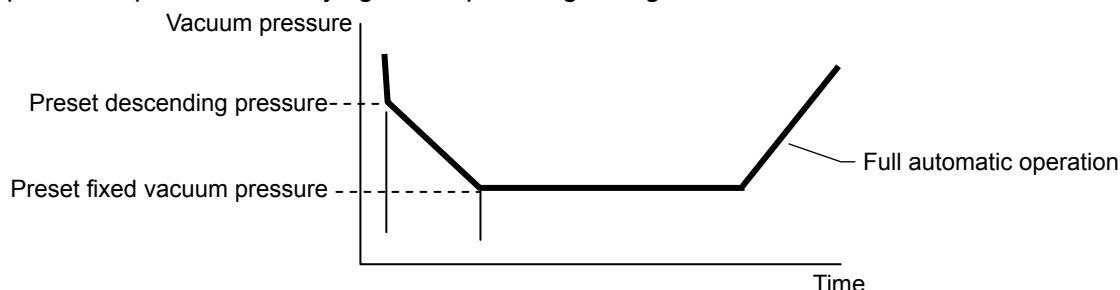

Screen	Procedures
<p>↓ ENTER key</p> <p>↓ START/STOP key</p>	<ol style="list-style-type: none"> Select the automatic operation II on the setting screen with the $\Delta \nabla$ keys, and then press the ENTER key. The screen changes to the setting screen. Press the $\Delta \nabla$ keys or DISPLAY key to advance the screen. After the bath temperature has been stable, press the START/STOP key to start the operation. The device automatically detects the evaporating temperature and automatically stops the operation.

Control/set the operating conditions.

Use the following procedures in order to change the operating conditions after performing one automatic operation.

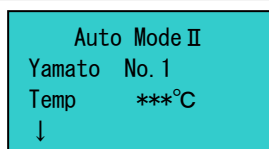

Perform on the setting screen.

- To create the operation name, → ENTER → (repeat " $\Delta \nabla$ → ENTER") → press ENTER longer
- Set the evaporating temperature.

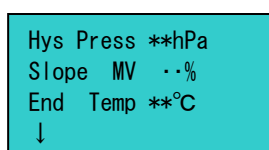

- Used to fine adjust the pressure ON/OFF width on the control solenoid valve at fixed temperature operation. ENTER → change the pressure with $\Delta \nabla$ → ENTER
- The descending curve on the descending operation can be fine adjusted by increments of %.
- Used to fine adjust the detecting range (temperature) of evaporating temperature at operation end.

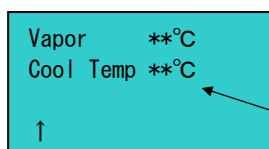

The measured evaporating temperature is displayed.

The cooling temperature is displayed when the optional cooling temperature sensor is connected.

Screen switching during the operation

Parameter indication can be switched to the Graphic indication by pushing a DISPLAY key for several seconds during the operation. It is indicated on the screen the process of present operation on and off, pressure and evaporating temperature are indicated at present.

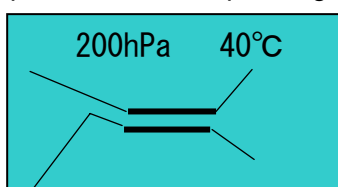

9. Description and Function of Each Part

Other Functions



Glass set and bath are sold separately.

Rotation control knob drive unit
It adjusts the rotation speed.

Rotary evaporator drive unit
The glass unit goes up and down by operating the lift up/down key. During the auto operating of RE801, it automatically goes up and down by operating the START/STOP key on the VR vacuum controller.

Rotor
It starts, stops and adjusts the rotation of rotary joint (sample flask) by the operation of rotation control knob.

Updown key
It's the rise, descending switch of the lift. Main unit slides in the rise direction while \wedge is being pushed and it slides in the descending direction while \vee is being pushed



Lift lower limit position control knob
It adjusts the lower limit position of lift when it is lowered. Move the lift to the uppermost position. Loosen the knob, push up to the proper position and then tighten it again to change the lowermost position of lift.

Adjuster
It is used to adjust the level of rotary evaporator.

9. Description and Function of Each Part

Other Functions

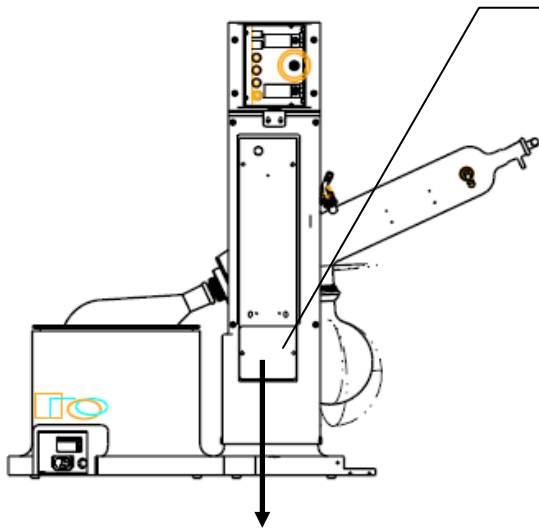

The lift up switch for the blackout

- A lift is raised when a lift switch for the blackout is pushed at the time of the blackout.
- The lift stops when a hand is left from the lift switch.
- It doesn't work even if a lift switch is pushed if it is the position of the upper limit.

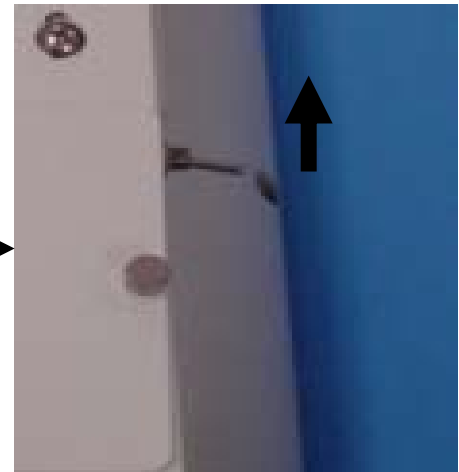

How to check a battery (9V alkaline dry cell)

- The lift is lowered with the lift down key in front of the device in the bottom position. Next, it keeps pushing a lift switch for the blackout in the rear. Confirm whether lift is raised to the upper limit within ten seconds.
- When rise time is more than ten seconds, it becomes the standard of the battery exchange time. An a little early exchange is suggested. Check a battery once a month.
- If battery use longtime, can not move lifter switch for power cut.
- Change the battery once a year regardless of use frequency.

WARNING!

- Be sure to disconnect the power cord during inspection or maintenance of device.
- Do not disassemble the device.
- Check a battery once a month.
- Change the battery once a year regardless of use frequency.

10.Exchange procedure of Pressure Sensor

Pressure sensor for organic solvent

There is a sensor manufactured by SUS for the organic solvent except for the standard specification. Ask to the nearest store, our company office or Customer Service Center in the case of pressure sensor exchange.

Input of compensation value is necessary to adapt it to the sensor replaced when the pressure sensor was replaced.

Compensation value is mentioned in the data seat attached to the sensor.

① Exchange procedure of pressure sensor

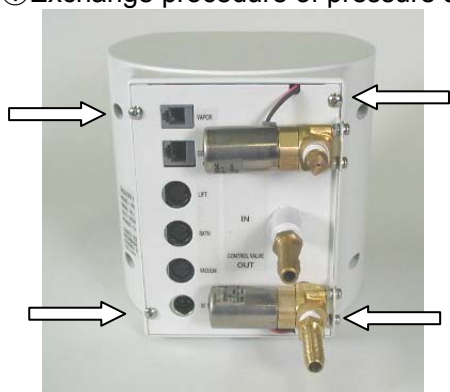

- (1) Remove all the cables, and remove the rear fixed four screws of four vacuum controller with a plus driver after you turned off the power.

Caution : Pull out of the main unit power supply code from the power supply plug surely.

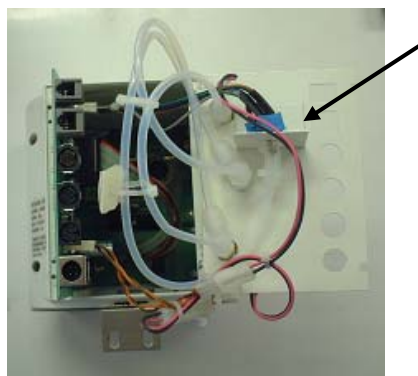

- (2) Remove the pressure sensor connection connector gently from the circuit board. Don't pull it forcefully, and don't twist it.
- (3) Remove the silicone tube of the pressure sensor connection.
- (4) Pressure sensor for exchange is connected and returned to before operation.



Standard sensor



SUS sensor for Organic solvent

- (5) Main unit power supply is turned on after a cables are connected.



MAINTENANCE key

- (6) Vacuum controller power supply is turned on, and compensation values are input from the MAINTENANCE key.

10.Exchange procedure of Pressure Sensor

Pressure sensor for organic solvent

②Input of compensation value

```
Press Switching
0. P-3000S
1. P-8300
```

```
Pressure Adjust
Pressure CAL X1
Pressure CAL Y1
↓
```

(1) Press Switching is chosen from the MAINTENANCE key. The kind of the pressure sensor is chosen and decided with ENTER key.

- 0. P-3000S : Standard sensor
- 1. P-8300 : SUS sensor for organic solvent

(2) Push and hold MAINTENANCE key for four seconds. The screen change on the Pressure Adjustment screen

(3) The compensation value is input based on the data seat attached to sensor for exchange. The parameter must input for points of X1, Y1, X2, Y2.

(4) The input of the compensation value.

c.f.

[DATA SHEET]			
ZERO :	-0.01	mV	
SPAN :	94.24	mV	
@	98.1	kPa	
	25°C	1,500mA	

X1 : The value(mV) of ZERO is input.

Y1 : The value of 0hPa is input.(It is the fixed value which was common to both sensors 0hPa.)

X2 : The value(mV) of SPAN is input.

Y2 : Translate kPa to hPa, and input 981hPa.
(It is the fixed value which was common to both sensors 981hPa.)

```
Pressure Adjust
Pressure CAL X1
Pressure CAL Y1
↓
```

①Pressure CAL X1 is chosen from the $\Delta \nabla$ keys and decided with ENTER key.

```
Pressure CAL X1
-0.01mV
```

②The value(mV) of ZERO is input. (-0.01mV in this case)

```
Pressure Adjust
Pressure CAL X1
Pressure CAL Y1
↓
```

③Screen changes when an ENTER key is pushed. Pressure CAL Y1 is chosen from the $\Delta \nabla$ keys and decided with ENTER key

```
Pressure CAL Y1
0 hPa
```

④The value(mV) of 0hPa is input.

10.Exchange procedure of Pressure Sensor

Pressure sensor for organic solvent

Pressure Adjust
Pressure CAL X2
Pressure CAL Y2
↑

- ⑤ Screen changes when an ENTER key is pushed.
Pressure CAL X2 is chosen from the Δ ∇ keys and decided with ENTER key.

Pressure CAL X1
94.24mV

- ⑥ The value(mV) of SPAN is input. (94.24mV in this case)

Pressure Adjust
Pressure CAL X2
Pressure CAL Y2
↑

- ⑦ Screen changes when an ENTER key is pushed.
Pressure CAL Y2 is chosen from the Δ ∇ keys and decided with ENTER key.

Pressure CAL Y2
981hPa

- ⑧ The value(mV) of 981hPa is input.

Caution : Teflon control solenoid valve

When it has an organic solvent used extensively, an optional pressure sensor for organic solvent and Teflon control solenoid valve for organic solvent are suggested to use.

Ask to the nearest store, our company office or Customer Service Center.

11. Handling Precautions

WARNING!

1. Substances that cannot be used

-  Never use explosive substances, flammable substances and substances that include explosive or flammable ingredients in this unit. Explosion or fire may occur. (Refer to page 71 "19. List of Dangerous Materials".)

2. If a problem occurs

-  If smoke or strange odor should come out of this unit for some reason, turn off the power key right away, and then turn off the circuit breaker and the main power. Immediately contact a service technician for inspection. If this procedure is not followed, fire or electrical shock may result. Never perform repair work yourself, since it is dangerous and not recommended.

3. Do not disassemble or modify this unit

-  Do not disassemble or modify this unit. Fire or electrical shock or failure may be caused.

4. Don't put things on Rotary Evaporator

-  If a thing is placed on a rotary evaporator, there is danger of fall. Moreover, if a solvent etc is placed, there is a possibility of becoming a cause of failure.

CAUTION!

1. During a thunder storm

-  During a thunderstorm, turn off the power switch immediately, then turn off the main power. If this procedure is not followed, fire or electrical shock may be caused.

2. Recovery after power failure

-  Turn off the power switch when a power failure occurs to avoid unmanned operation.
After a power failure return, since it is dangerous that it will be in operational status by uninhabited, please once turn off the power switch at the time of a power failure.

3. About the battery

-  Confirm the polarity of the electrode.
When an electrode is connected in the opposite direction, a problem occurs, and dangerous.
Don't mix the different kind of battery .
Remove a battery when you don't use for a long time.

12.Maintenance Method

Daily Inspection and Maintenance

For the safety use of this unit, please perform the daily inspection and maintenance without fail. Using the city water to this unit might attach dirt. Do inspect and maintain this point while performing daily inspection and maintenance.

WARNING!

- Be sure to disconnect the power cord during inspection or maintenance of device.
- Do not disassemble the device.
- Check a battery once in the moon.
- Change the battery once a year regardless of use frequency.

CAUTION!

- Wipe the dirt with soft cloth wrung out with mild detergent. Do not use benzene, thinner or cleanser, or do not scrub it with a scrubbing brush. Deformation, deterioration or discoloration may result in.

For any questions, contact the dealer who you purchased this unit from, or the nearest sales division in our company.

13. Long storage and disposal

When not using this unit for long term / When disposing

CAUTION!

When not using this unit for long term...

- Turn off the power and disconnect the power cord.
- Remove the battery stored by the equipment back.

WARNING!

When disposing...

- Keep out of reach of children.
- Remove and discard a power cord.
- Usually, discard by bulky garbage treatment.

Environmental protection should be considered

We request you to disassemble this unit as possible and recycle the reusable parts considering to the environmental protection. The feature components of this unit and materials used are listed below.

Component Name	Material
Exterior Parts	
Outer covering	Aluminum printed coating, ABS resin
Electrical Parts	
Switches, Relay	Composite of resin, copper and other
Circuit boards	Composite of glass fiber and other
Power cord	Composite of resin coating, copper, nickel and other
Wiring material	Composite of flame-resistant vinyl, copper and nickel
Sticker	Resin material
Battery	9V alkaline dry cell

14.In the Event of Failure...

Safety Device and Error Code

Turn off the power and disconnect the plug immediately if the liquid leaks into the device. There is a danger of electric shock if the power is turned on after the device is dried. In this case, please call the service department of our company.

Error Code:

Check the error code and stop the operation immediately.

1.RE main unit

Error Display	Cause/Solution
E04	When abnormalities boil up on RE main unit rotor, "E04" is displayed on a screen and rotation stops. It boil up, when motor disconnection, a motor lock, and the inside temperature of a motor detect the abnormalities in overheating. From a glass set, please check whether the motor is locked and carry out resumption of after-release operation of the unusual conditions. Please carry out a service call, when you cannot cancel from a power supply re-injection.
E15	When abnormalities are in a storage cell, "E15" is displayed on a screen, and equipment stops. Since it becomes board exchange when it cannot cancel from a power supply re-injection, please carry out a service call.
---(Underbar)	When motor rotation speed frequency is less than 3rpm, ". . ." is displayed on a screen. If rotation speed frequency goes up, it will return automatically.
--- (Topbar)	When motor rotation speed frequency is 255rpm more, "- - -" is displayed on a screen. If rotation speed frequency falls, it will return automatically.

Refer to the instruction manual of VR model for the display of abnormality on the vacuum controller.

2. Vacuum controller(VR)

Error Display	Cause/Solution	Screen
Abnormality in memory	Error in preset value memorized. The device stops when this error occurs. Replace the board.	Memory err Break Down Please Repair CANCEL to BuzOFF
Abnormality at power failure	The display appears at the recovery after power failure. The device stops operation. Cancel the error with the CANCEL key.	Power failure CANCEL to Clear
Abnormality in rotor	An abnormality occurs in the rotor of RE main body. The device stops when this error occurs. Cancel the error by restoring the breaker.	Rotar err Breaker Reset CANCEL to BuzOFF
Abnormality in jack	An abnormality occurs in the jack (lifter) of RE main body. The device stops when this error occurs. Cancel the error by restoring the breaker.	Juck err Breaker Reset CANCEL to BuzOFF
Abnormality in pressure sensor	The display appears when the measured pressure is in the outside of measurement range, or when the pressure sensor is defective. The device stops when this error occurs. Cancel the error by restoring the breaker. Repair the board or replace the pressure sensor if the error can not be canceled.	Pressure err Confirm Sensor Breaker Reset CANCEL to BuzOFF

14.In the Event of Failure...

Safety Device and Error Code

2. Vacuum controller(VR)

Error Display	Cause/Solution	Screen
Abnormality in evaporating temperature sensor	The display appears when the temperature exceeds the measurement range, or when the sensor is defective. The device stops when this error occurs. Cancel the error by restoring the breaker. Repair the board or replace the sensor if the error can not be canceled.	Vapor Sensor err Confirm Sensor Breaker Reset CANCEL to BuzOFF
Abnormality in cooling temperature sensor	The display appears when the temperature exceeds the measurement range, or when the sensor is defective. The device stops when this error occurs. The device stops when this error occurs. Cancel the error by restoring the breaker. Repair the board or replace the sensor if the error can not be canceled.	Cool Sensor err Confirm Sensor Breaker Reset CANCEL to BuzOFF
Bath abnormality	Overheating prevention circuit on the bath is activated. The device stops when this error occurs. Check the cause of abnormality. Cancel the error by restoring the breaker.	Bath err Confirm Route STR/STP to Clear CANCEL to BuzOFF
Leak abnormality	The display appears when the vacuum pressure does not increase after 10 seconds has passed since the LEAK key is pressed. The device stops operation after one minute from the error display. It automatically returns if the error is cancelled within one minute. Check the vacuum route and cancel the error by pressing the START/STOP key.	Leak err Confirm Route STR/STP to Clear CANCEL to BuzOFF
Abnormality in start pressure	The display appears when the measured pressure does not lower below the preset pressure after ten minutes has passed since the start of operation. The device stops operation after one minute from the error display. It automatically returns if the error is cancelled within one minute. Check the vacuum route and cancel the error by pressing the START/STOP key.	Pressure err Confirm Pump STR/STP to Clear CANCEL to BuzOFF

14. In the Event of Failure...

Safety Device and Error Code

(Continued from previous page)

Error	Cause/Solution	Screen
Pressure abnormality	<p>The display appears in the fixed temperature, fixed temperature timer, descending, or descending timer operation after one minute has passed since the measured pressure goes outside the range of preset pressure \pm hysteresis.</p> <p>It also appears in the automatic operation mode after the specified one minute has passed since the measured pressure goes outside the range of preset pressure (the pressure value at the preset temperature) \pm hysteresis.</p> <p>The device stops operation after one minute from the error display.</p> <p>It automatically returns if the error is cancelled within ten minute.</p> <p>Check the vacuum route and cancel the error by pressing the START/STOP key.</p>	<p>Pressure err Confirm Route STR/STP to Clear CANCEL to BuzOFF</p>
Abnormality in evaporating temperature	<p>The display appears when the evaporating temperature exceeds the setting range of abnormal temperature.</p> <p>Display only Auto return</p>	<p>Vapor err Confirm Route CANCEL to BuzOFF</p>
Abnormality in cooling water temperature	<p>The display appears when the cooling water temperature exceeds the setting range of abnormal temperature.</p> <p>Display only Auto return</p>	<p>Cool err Confirm Water CANCEL to BuzOFF</p>
Abnormality in auto operation temperature	<p>The display appears when the temperature has not reached the auto operation temperature after three hours passed since the start or end of operation.</p> <p>Display only Auto return</p>	<p>Pressure err Confirm Route CANCEL to BuzOFF</p>

Trouble Shooting

Phenomenon	Check point
It does not move up and down, even if it pushes a lift up-and-down switch.	<ul style="list-style-type: none"> Is the power receptacle contained? Is the breaker set to ON? Is already a lift in the highest score?
It does not rotate.	<ul style="list-style-type: none"> If the rotor stops due to the overload on the rotor motor, turn off the power for about 30 minutes to cool inside the motor. Remove the cause of overheat and reduce the overload.
Device does not start after turning on the power switch.	<ul style="list-style-type: none"> Check if the power source is turned to on. Check if the power cable is securely plugged. Check if a power failure occurs.
Overload on rotor motor?	<ul style="list-style-type: none"> If the rotor stops due to the overload on the rotor motor, turn off the power for about 30 minutes to cool inside the motor. Remove the cause of overheat and reduce the overload.

In the case if the error other than listed above occurred, turn off the power switch and primary power source immediately. Contact the shop of your purchase or nearest Yamato Scientific Service Office.

15.After Service and Warranty

When requesting a repair

When requesting a repair

If any trouble occurs, immediately stop operation, turn the ELB off, pull out the power plug and contact your dealer or our sales office.

Information necessary for requesting a repair

- Model name of the product
 - Serial number
 - Date(y/m/d) of purchase
 - Description of trouble (as in detail as possible)
- } See the warranty card or the nameplate on the unit.
} See the section "Names and Function of Parts"

Be sure to indicate the warranty card to our service representative.

Warranty card (attached separately)

- Your dealer or one of our sales offices will hand you a warranty card. Please fill necessary data such as "dealer name, date of purchase, etc" and store at a safe place.
- Warranty period is one full year from the date of purchase. Repair service for free is available according to the conditions written on the warranty card.
- For repairs after the warranty period consult your dealer or one of our sales office. Paid repair service is available on your request when the product's functionality can be maintained by repair.

Minimum holding period of repair parts

The minimum holding period of repair parts for this product is seven years after end of production.

Repair parts here refer to parts necessary for maintaining performance of the product.

16.Specification

1.RE main unit

Model		RE601	RE801	
Configuratio n	Rotary motor	DC brushless motor with feedback control		
	Rotation speed	20~250r/min		
	Lift motor	Rod actuator		
	Use surrounding temperature range	5~35°C		
Performance /function	Lift stroke	130mm		
	Lift function	Electrical operation and Auto		
	Display	Rotation unit: liquid crystal display LCD display (Japanese/English characters)		
	Setting system	Rotation unit: dial Vacuum control unit: keying		
	Outer covering	ABS resin, aluminum coating finish		
	Setting range of vacuum degree	0~981hPa		
	Measurement range of vacuum degree	0~1033hPa		
	Resolution of vacuum degree	1hPa		
	Setting range of hysteresis	1~50hPa		
	Indicated resolution of evaporating temperature	Selective: 1°C or 0.1°C		
	Indicated resolution of cooling water temperature	Optional, Selective: 1°C or 0.1°C		
	Operational function	Fixed temperature, Fixed temperature timer, Descending, Descending timer	Fixed temperature, Fixed temperature timer, Descending, Descending timer, Automatic I, II	
	Timer setting range	Fixed temperature timer: 1 to 999 hours, Descending timer: 1 to 99 hours		
	Memory function	10 functions for each operation		
	Data operation	53 kinds of solvent data at fixed temperature, fixed temperature timer, descending, or descending timer operation		
	Safety function	Main unit	Circuit breaker · Rotor overload protection · Lower limit of lift by manual Lift rise switch at Blackout	
Vacuum controller		Self diagnosis function Interlock stop function of main unit and bath at abnormaly		
Interlocking function		Bath auto stop/heat-retention, abnormal stop		
Standard	External dimension	glass set A equipped	W828 × D400 × H727 (857: at lift-up)	
		glass set B/C equipped	W643 × D400 × H727 (857: at lift-up)	
	Rating		Main unit: AC100V~240V 1.5A Vacuum controller: DC24V 1A and below	
Weight		Approx. 15.1kg (Glass and bath not included)		
Accessories of main unit		<ul style="list-style-type: none"> • Vacuum seal (1) • Rotary joint retainer (1) • O-ring (1) • Ring(large/middle/small) (each 1) • Condenser fixing nut (1) • Coil ring (1) 		
Accessories		<ul style="list-style-type: none"> • Bath ways (1) • Instruction manual (1) • Warranty card (1) • Battery(9V) (2) 		

16.Specification

2. Vacuum controller(VR)

Model	Vacuum controller RE601 Model	Vacuum controller RE801 Model
Display	LCD display (Kanji/English characters)	
Setting method	Keying	
Outer covering	ABS resin, coating finish	
Rating	DC24V 0.5A or less	
Setting range of vacuum degree	0~981hPa	
Measurement range of vacuum degree	0~1033hPa	
Resolution of vacuum degree	1hPa	
Setting range of hysteresis	1~50hPa	
Indicated resolution of evaporating temperature	Selective: 1°C or 0.1°C	
Indicated resolution of cooling water temperature	Optional, Selective: 1°C or 0.1°C	
Operational function	Fixed temperature, fixed temperature timer, descending, descending timer	Fixed temperature, fixed temperature timer, descending, descending timer, automatic I, II
Setting range of timer	Fixed temperature timer: 1 to 999 hours, descending timer: 1 to 99 hours	
Memory function	10 functions for each operation other than free operation	
Data operation	53 kinds of solvent data at fixed temperature, fixed temperature timer, descending, or descending timer operation	
Safety feature	Refer to "14. Safety Feature".	
Interlocking function	Bath auto stop/heat-retention, abnormal stop	

17.Wiring Diagram

• RE601/801 main unit

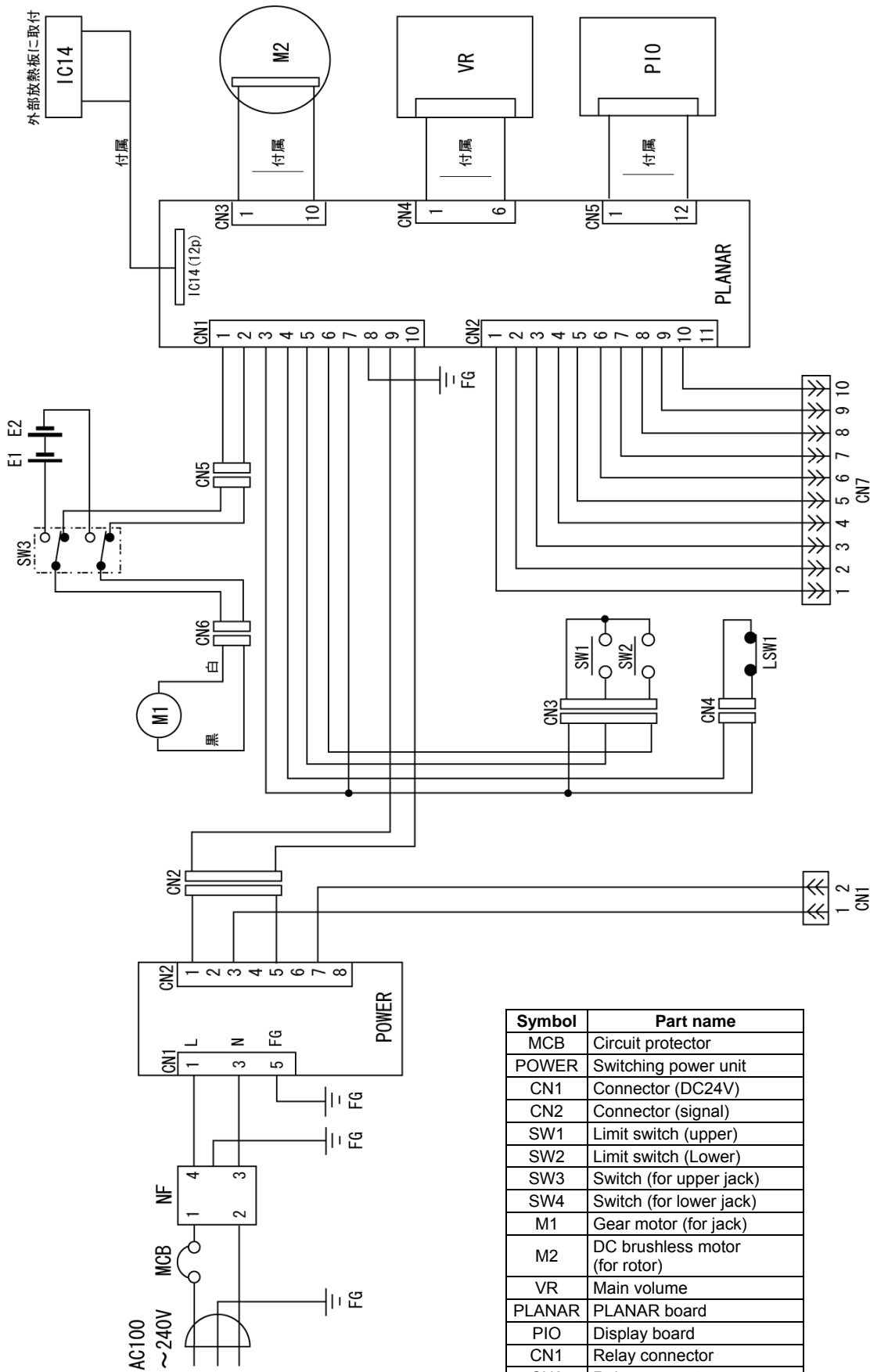

17. Wiring Diagram

• Vacuum controller (VR)

AC100~240V

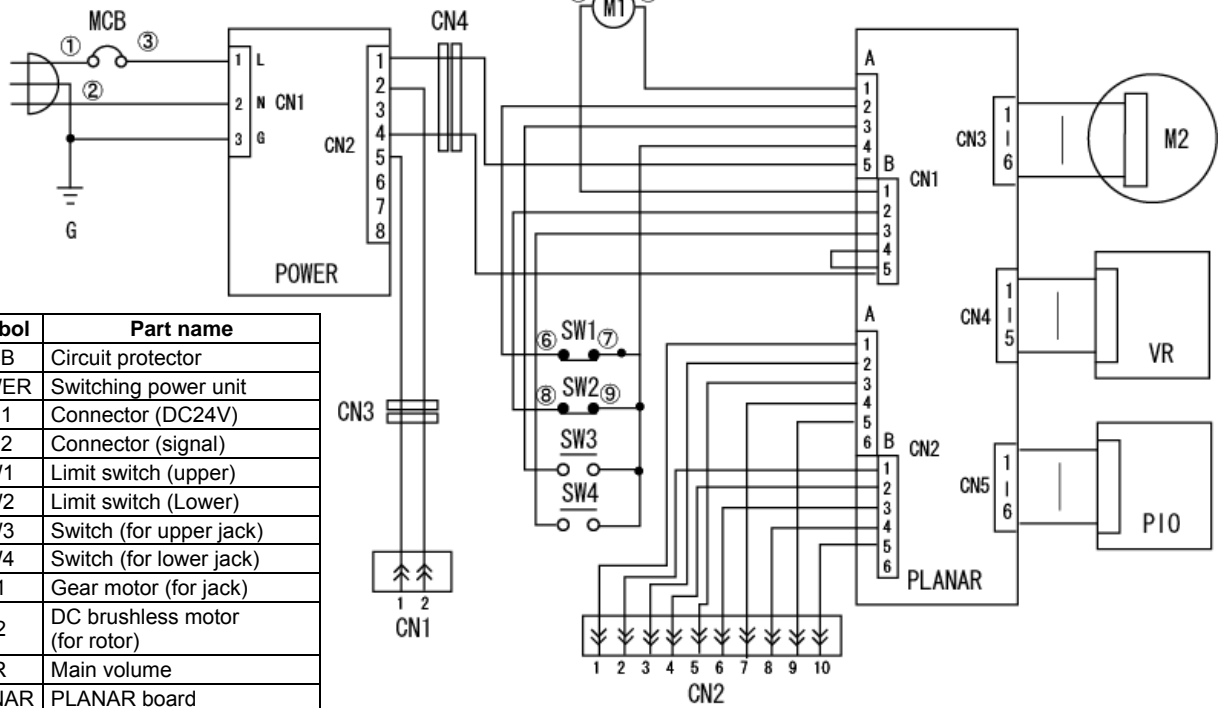

Symbol	Part name
MCB	Circuit protector
POWER	Switching power unit
CN1	Connector (DC24V)
CN2	Connector (signal)
SW1	Limit switch (upper)
SW2	Limit switch (Lower)
SW3	Switch (for upper jack)
SW4	Switch (for lower jack)
M1	Gear motor (for jack)
M2	DC brushless motor (for rotor)
VR	Main volume
PLANAR	PLANAR board
PIO	Display board
CN1	Relay connector
CN2	Relay connector

18.Replacement Parts Table

1.RE601/801 main unit

Part Name	Code No.	Specification	Manufacturer
Ring (large)	RE50040190		Yamato Scientific
Ring (middle)	LT00015384		Yamato Scientific
Ring (small)	RE50040070		Yamato Scientific
O-ring	4210020010	Viton P22,	Yamato Scientific
Rotary joint retainer	RE50040080		Yamato Scientific
Condenser mounting nut	RE50040700		Yamato Scientific
Coil ring	2551720503	SUS304WPA,	Yamato Scientific
Battery holder	LT00033690	BH-9V-2	TAKACHI Electricity Industry

Refer to the instruction manual of VR model for the components of VR model.

2.Vacuum controller (VR)

Part Name	Code No.	Specification	Manufacturer
Control/leak solenoid valve *	LT00030631	VDW21-5G-1-01-A	SMC
Display board	LT00013601	VR300/600/800 display board	TOHO
Pressure sensor *	LT00015077	P-3000S-102-A-10 Harness attached	Yamato Scientific
Evaporating temperature sensor	LT00015051	Pt100 Ω Teflon lead wire for platinum resistor bulb/ glass protective tube	Yamato Scientific
DC power cable	LT00015073	VR300—42000	Yamato Scientific
VR601 control board	LT00033695	VR601/801-PLANAR Specification is required at order	TOHO
VR801 control board	LT00033695	VR601/801 Specify the model at order.	TOHO
Rotor jack signal cable	LT00015074	VR600-42000	Yamato Scientific
Bath signal cable	LT00015075	VR600-42010	Yamato Scientific

3. Option parts

Part Name	Code No.	Specification	Manufacturer
Teflon control solenoid valve *	LT00034615	VDW21-5G-1-01-L-X133 Connector attached	SMC
Pressure sensor for solvent *	LT00015313	P-8300-102A-10 Teflon case and harness attached	Yamato Scientific
Cooling water temperature sensor	LT00015315	Pt100 Ω Teflon lead wire for platinum resistor bulb/ glass protective tube	Yamato Scientific
Teflon vacuum seal *	ORE7042000	ORE70-42000	Yamato Scientific
Flask clamp (for distillation flasks)	LT00034372	The product made from SUS	Yamato Scientific
Flask clamp (for carrier flasks)	RE51A0237A	The product made from SUS	Yamato Scientific

18.Replacement Parts Table

4. Main unit related consumable part

Part Name	Code No.	Specification	Manufacturer
Vacuum seal	RE50040090	RE500-40091	Yamato Scientific
Flask clamp (1)	F0410001	KC29 Black	Yamato Scientific
Flask clamp (2)	F0410005	KC35 Black	Yamato Scientific
Nozzle Cautions3	LT00016191	ORG10_4000_X	Ikeda Glass
Packing for nozzle Cautions 3	LT00016192	ORG10_4001_X	Ikeda Glass
Cap for nozzle Cautions 3	LT00016193	ORG10_4002_X	Ikeda Glass
Hose clamp	LT00016196		Ikeda Glass
Battery (9V alkaline dry cell)	LT00033689	6LR61XJ/2B 9V Two pieces	Panasonic
Vacuum hose	LT00016675	1.0m	ARAMU

* It is an article of consumption.

Consumable supplies related to main body(Take in vacuum controller(VR))

Caution:

1. Use the optional Teflon vacuum seal for ketone and an ether system solvent.
Acetone, methyl ethyl ketone, methyl isobutyl ketone, ethyl ether, and MTBE (methyl t-butyl ether) etc.
-- the case where ketone and an ether system solvent are used -- vacuum seal (NBR) of standard attachment It will swell.
Use the fluorocarbon polymers vacuum seal of an option.
2. See the catalog of Yamato science when you replace a glass set.
3. Exchange Nozzle, Packing for nozzle and Cap for nozzle in a set.

19. List of Dangerous Materials



Never use explosive substances, flammable substances and substances that include explosive or flammable ingredients in this unit.

EXPLOSIVE

EXPLOSIVE:	Ethylene glycol dinitrate (nitro glycol), Glycerin trinitrate (nitroglycerine), Cellulose nitrate (nitrocellulose), and other explosive nitrate esters
	Trinitrobenzene, Trinitrotoluene, Trinitrophenol (picric acid), and other explosive nitro compounds
	Acetyl hidroperoxide (peracetic acid), Methyl ethyl ketone peroxide, Benzyl peroxide, and other organic peroxides

FLAMMABLE

IGNITING:	Lithium (metal), Potassium (metal), Sodium (metal), Yellow phosphorus, Phosphorus sulfide, Red phosphorus, Celluloid compounds, Calcium carbide, Lime phosphate, Magnesium (powder), Aluminum (powder), Powder of metals other than magnesium and aluminum, Sodium hydrosulfite
OXIDIZING:	Potassium chlorate, Sodium chlorate, Ammonium chlorate, and other chlorate
	Potassium perchlorate, Sodium perchlorate, Ammonium perchlorate, and other perchlorate
	Potassium peroxide, Sodium peroxide, Barium peroxide, and other inorganic peroxide
	Potassium nitrate, Sodium nitrate, Ammonium nitrate, and other nitrate
	Sodium chlorite and other chlorites
INFLAMMABLE LIQUID:	Calcium hypochlorite and other hypochlorites
	Ethyl ether, Gasoline, Acetaldehyde, Propylene chloride, Carbon disulfide, and other flammable substances having a flash point of lower than -30°C
	Normal hexane, ethylene oxide, acetone, benzene, methyl ethyl ketone, and other flammable substances having a flash point of -30°C or higher but lower than 0°C
	Methanol, Ethanol, Xylene, Pentyl acetate (amyl acetate), and other flammable substances having a flash point of 0°C or higher but lower than 30°C
FLAMMABLE GAS:	Kerosene, Light oil (gas oil), Oil of turpentine, Isopentyl alcohol (isoamyl alcohol), Acetic acid, and other flammable substances having a flash point of 30°C or higher but lower than 65°C
	Hydrogen, Acetylene, Ethylene, Methane, Propane, Butane, and other flammable substances which assume a gaseous state at 15°C and 1 atm

(Source: Appendix Table 1 of Article 6 of the Industrial Safety and Health Order in Japan)

20. Standard Installation Manual

* Install the unit according the procedure described below (check options and special specifications separately).

Model	Serial number	Date	Person in charge of installation (company name)	Person in charge of installation	Judgment

No.	Item	Method	Reference operation manual	Judgment
Specifications				
1	Accessories	Check the quantities of accessories with the quantities shown in the Accessory column.	16.Specification	P.65
2	Installation	<ul style="list-style-type: none"> • Visually check the surrounding area. Caution: Be careful about surrounding environment.	3.Before Using This Unit "2. Choose a proper place for installation"	P.6
		<ul style="list-style-type: none"> • Keep space. 		
3	Installation situation	<ul style="list-style-type: none"> • It is checked whether load is applied to a cooling hose by the upper and lower sides of a lift. 	5.Installation Method	P.17
Operation				
1	Power voltage	<ul style="list-style-type: none"> • Using a tester, measure the voltage of the voltage used by the customer (distribution board, outlet, etc.). • Measure the voltage during operation (the voltage must be within the standard). Caution: When a unit is to be connected to the plug or breaker, use one that conforms to the standard.	3.Before Using This Unit "1. Always ground this unit"	P.6
			3.Before Using This Unit "7. Choose a correct power distribution board or receptacle"	P.7
			16.Specification	P.65
2	Start of operation	<ul style="list-style-type: none"> • Start operation. 	7.Operation Function "Basic Operation"	P.27
			11.Handling Precautions	P. 58
Description				
1	Description of operation	Explain the operation of each unit to the customer according to this Operation Manual.	All	
2	Error code	Explain error codes and the procedure for resetting them to the customer according to this Operation Manual.	14.In the Event of Failure...	P.61
3	Maintenance inspection	Explain the operation of each unit to the customer according to this Operation Manual.	12.Maintenance Method	P.59
4	Completion of installation Information to be entered	<ul style="list-style-type: none"> • Enter the date of installation and the name of the person in charge of installation on the face plate on the unit. • Enter necessary information on the guarantee, and pass it to the customer. • Explain the after-sale service route to the customer. 	15.After Service and Warranty	P. 64

Limited liability

Be sure to use the unit strictly following the handling and operating instructions in this operating instruction.

Yamato Scientific Co.,Ltd. Assumes no responsibility for an accident or a malfunction caused by use of this product in any way not specified in this operating instruction.

Never attempt to perform matters prohibited in this operation instruction. Otherwise, an unexpected accident may result.

Notice

- Descriptions in this operating instruction are subject to change without notice.
- We will replace a manual with a missing page or paging disorder.

Instruction Manual for
Rotary Evaporator
Model RE601/801
Feb. 28, 2010

Yamato Scientific Co., Ltd.

2-1-6 Nihonbashi Honcho, Chuo-ku,
Tokyo, 103-8432, Japan

<http://www.yamato-net.co.jp>